



**MATERIALES
PARA
OBRAS Y
REFORMAS**

FABRICACIÓN DE PIEZAS ESPECIALES
IMITACIÓN MADERA, PIEDRA ARTIFICIAL Y HORMIGÓN DECORATIVO

**CATÁLOGO PIEDRA ARTIFICIAL
2019**

TABLA DE CONTENIDOS

INTRODUCTION

VIGAS Y PÉRGOLAS
(BLANCO, GRIS, IMITACIÓN MADERA)

BALAUSTRADAS Y TERMINACIONES

BARANDAS HORMIGÓN

CUBREMUROS Y PIEDRAS

PIEZAS DE ALEROS Y VENTANAS

CHIMENEAS

BORDILLOS

PISCINA Y JARDÍN

JARDINERAS

HORMIGÓN IMITACIÓN MADERA

PILAS PARA LAVAR

COLUMNAS Y PILARES

REVESTIMIENTOS



INTRODUCCIÓN

MATERIALES DE CONSTRUCCION MELCHOR E HIJOS S.L.

Empresa fundada en 1990 dedicada ala venta y fabricación de materiales de construcción.

Transporte propio con camiones grúa y contenedores, equipados con dispositivos de control de flota para ofrecer una gestión de calidad en los pedidos de nuestros clientes.

En nuestra exposición encontrará representados gran parte de los productos que fabricamos como:

Vigas Pérgolas Fuentes, Bancos, Balaustradas, Barandas, Cubremuros, Aspiradores estáticos, Bordillos, Jardineras, Productos para Piscinas, , Pilas para lavar, Columnas, Arcos Árabes, etc...

Nos adaptamos a las necesidades de nuestros clientes, por lo que hacemos piezas personalizadas y a medida.

Estamos en continúa expansión, por lo que no dejamos de incorporar nuevos modelos a nuestro catálogo.

Disponemos los mejores profesionales para la instalación de nuestros materiales

SOMOS DISTRIBUIDORES

GRUP **GAMMA**

VIGAS IMITACIÓN MADERA

CON LA ELEGANCIA DE LA MADERA Y LAS VENTAJAS DEL HORMIGÓN

Gama de colores básicos



NEGRA VETEADA



NEGRA



ROBLE



TEKA



PINO



NOGAL OSCURO
TOP VENTAS

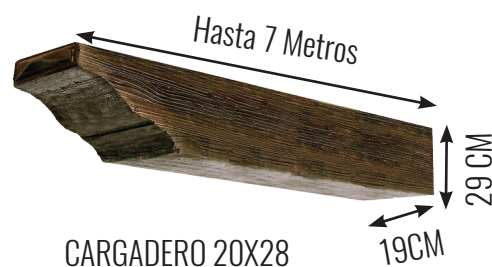

NOVEDAD 2019

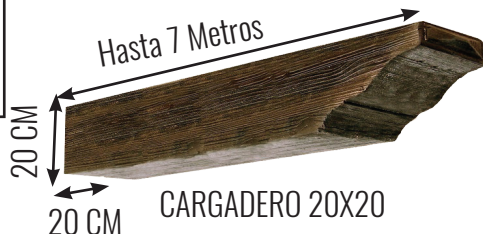

NOVEDAD 2019

LARGO DE VIGAS HASTA 7 METROS

VIGAS IMITACIÓN MADERA

VIGA IMITACIÓN MADERA 7X14 CM



MEDIDAS	PRECIO	REFERENCIA
HASTA 2,99 ML	23,35 €/ml	HORDEC053
DE 3,00 A 6,00 ML REFORZADA	26,5 €/ml	HORDEC054

Nota: A PARTIR DE 3 ML, LAS VIGAS TIENEN QUE IR REFORZADAS. VIGAS DECORATIVAS NO VÁLIDAS PARA FORJADO.

VIGA IMITACIÓN MADERA 10X18

MEDIDAS	PRECIO	REFERENCIA
HASTA 2,99 ML DE LARGO	30 €/ml	HORDEC056
DE 3,00 A 6,00 ML DE LARGO	53, €/ml	HORDEC058

Nota: A PARTIR DE 3 ML, LAS VIGAS TIENEN QUE IR REFORZADAS

VIGA IMITACIÓN MADERA 20X20

MEDIDAS	PRECIO	REFERENCIA
HASTA 7,00 DE LARGO	60 €/ml	HORDEC059



VIGA IMITACIÓN MADERA 14X28

MEDIDAS	PRECIO	REFERENCIA
HASTA 7,00 DE LARGO	70 €/ml	HORDEC060



VIGA IMITACIÓN MADERA 20X40 CM

MEDIDAS	PRECIO	REFERENCIA
HASTA 7,00 DE LARGO	100 €/ml	HORDEC055

VIGA IMITACIÓN MADERA 19X29

MEDIDAS	PRECIO	REFERENCIA
HASTA 7,00 DE LARGO	120 €/ml	HORDEC064



PÉRGOLAS Y CARGADEROS

VIGA PÉRGOLAS DE 7X14 CM

MEDIDAS	COLOR	PRECIO	REFERENCIA
HASTA 3,99 ML	Gris	15 €/ml	HORDEC067
	Blanco	16,5 €/ml	HORDEC068
DE 4,00 A 6,00 ML	Gris	19 €/ml	HORDEC069
	Blanco	20,5 €/ml	HORDEC070

Nota: VIGAS DECORATIVAS NO VÁLIDAS PARA FORJADOS

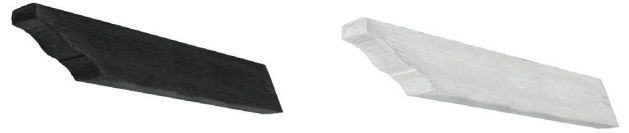

CARGADEROS PÉRGOLAS 10X20 CM

MEDIDAS	COLOR	PRECIO	REFERENCIA
HASTA 2,99 ML	Gris	33,5 €/ml	HORDEC081
	Blanco	35 €/ml	HORDEC082
DE 3,00 A 06,00 ML	Gris	35 €/ml	HORDEC083
	Blanco	36,5 €/ml	HORDEC084

Nota: A PARTIR DE 3 ML, LAS VIGAS TIENEN QUE IR REFORZADAS

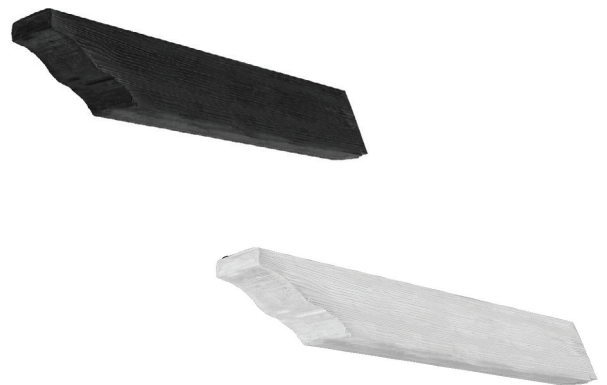

CARGADEROS PÉRGOLAS 15X25 CM

MEDIDAS	COLOR	PRECIO	REFERENCIA
HASTA 2,99 ML	Gris	45 €/ml	HORDEC089
	Blanco	46,5 €/ml	HORDEC090
DE 3,00 A 07,00 ML	Gris	46,5 €/ml	HORDEC091
	Blanco	48,5 €/ml	HORDEC092

Nota: A PARTIR DE 3 ML, LAS VIGAS TIENEN QUE IR REFORZADAS



LA SECCIÓN DE LAS VIGAS SE PUEDEN MODIFICAR, CONSÚLTENOS

MÓDULOS IMITACIÓN

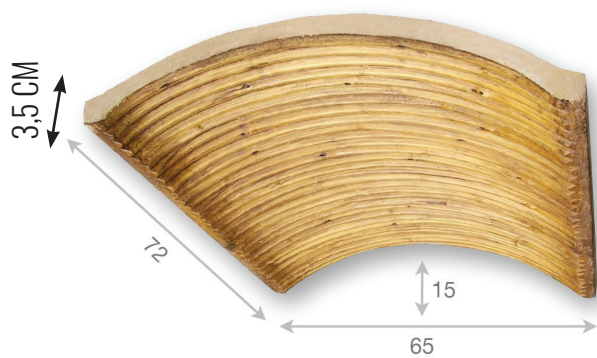

MÓDULO CURVO IMITACIÓN CAÑA
Referencia HORDEC178
26,62€

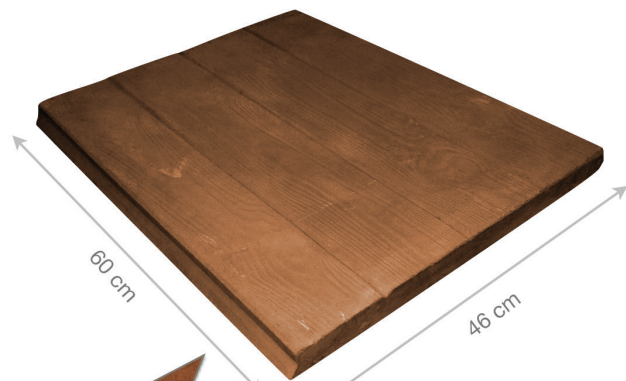

MÓDULO RECTO IMITACIÓN MADERA
Referencia HORDEC063
15,€



MÓDULO RECTO IMITACIÓN CAÑA
Referencia HORDEC174
21,50€

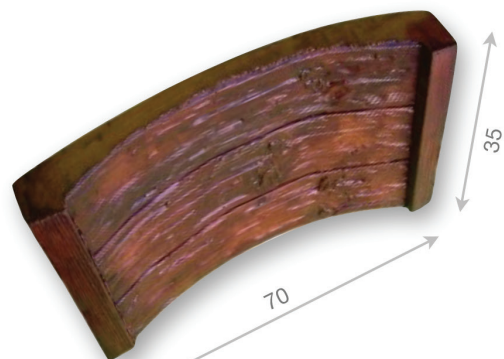

MÓDULO CURVO IMITACIÓN MADERA
Referencia HORDEC064
15,€

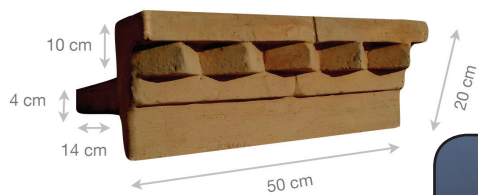

TABICA MODELO PICO GORRIÓN
Referencia HORDEC188
13,35€



BALAUSTRADA

BALAUSTRE ROMA

DESCRIPCIÓN	REFERENCIA	PRECIO
Metro lineal 98 cm	HORBAL144	23,20 €
Metro lineal 98 cm escalera	HORBAL145	36,00 €
Metro lineal 73 cm	HORBAL146	28,50 €
Metro lineal 73 cm escalera	HORBAL147	32,20 €
NÚMERO DE PIEZAS		
1 BASE BAJA,5 BALAUSTRAS, 1 BASE PASAMANOS,1 PASAMANOS		



PILARES NO INCLUIDOS

BALAUSTRE ATENAS

DESCRIPCIÓN	REFERENCIA	PRECIO
Metro lineal 98 cm	HORBAL081	28,75 €
Metro lineal 98 cm escalera	HORBAL152	31,60 €
Metro lineal 78 cm	HORBAL153	31,90 €
Metro lineal 78 cm escalera	HORBAL154	35,75 €
Metro lineal 63 cm	HORBAL155	28,00 €
Metro lineal 63 cm escalera	HORBAL156	30,80 €
NÚMERO DE PIEZAS		
1 BASE BAJA,5 BALAUSTRAS, 1 BASE PASAMANOS,1 PASAMANOS		



PILARES NO INCLUIDOS

BALAUSTRE MALAGA

DESCRIPCIÓN	REFERENCIA	PRECIO
Metro lineal 102 cm	HORBAL148	28,50 €
Metro lineal 102 cm escalera	HORBAL149	31,50 €
Metro lineal 78 cm	HORBAL150	25,60 €
Metro lineal 78 cm escalera	HORBAL151	28,50 €
NÚMERO DE PIEZAS		
1 BASE BAJA,5 BALAUSTRAS, 1 BASE PASAMANOS,1 PASAMANOS		



PILARES NO INCLUIDOS

BALAUSTRADA

BALAUSTRE FLORAL

DESCRIPCIÓN	REFERENCIA	PRECIO
Metro lineal 102 cm	HORBAL160	32,20 €
Metro lineal 102 cm escalera	HORBAL102	36,00 €
Metro lineal 73 cm	HORBAL158	31,90 €
Metro lineal 73 cm escalera	HORBAL159	35,75 €
NÚMERO DE PIEZAS		
1 BASE BAJA,5 BARROTES, 1 BASE PASAMANOS,1 PASAMANOS		



PILARES NO INCLUIDOS

BALAUSTRE ALHAMBRA

DESCRIPCIÓN	REFERENCIA	PRECIO
Metro lineal 93 cm	HORBAL160	28,50 €
Metro lineal 93 cm escalera	HORBAL161	31,50 €
Metro lineal 102 cm	HORBAL162	36,00 €
Metro lineal 102 cm escalera	HORBAL163	39,60 €
NÚMERO DE PIEZAS		
1 BASE BAJA,5 BARROTES, 1 BASE PASAMANOS,1 PASAMANOS		



PILARES NO INCLUIDOS

BALAUSTRE GRANADA

DESCRIPCIÓN	REFERENCIA	PRECIO
Metro lineal 102 cm	HORBAL164	32,20 €
Metro lineal 102 cm escalera	HORBAL165	35,00 €
NÚMERO DE PIEZAS		
1 BASE BAJA,5 BARROTES, 1 BASE PASAMANOS,1 PASAMANOS		



PILARES NO INCLUIDOS

BALAUSTRE CÓRDOBA

DESCRIPCIÓN	REFERENCIA	PRECIO
Metro lineal 102 cm	HORBAL166	32,00 €
Metro lineal 102 cm escalera	HORBAL167	35,00 €
NÚMERO DE PIEZAS		
1 BASE BAJA,5 BARROTES, 1 BASE PASAMANOS,1 PASAMANOS		



PILARES NO INCLUIDOS

BALAUSTRES

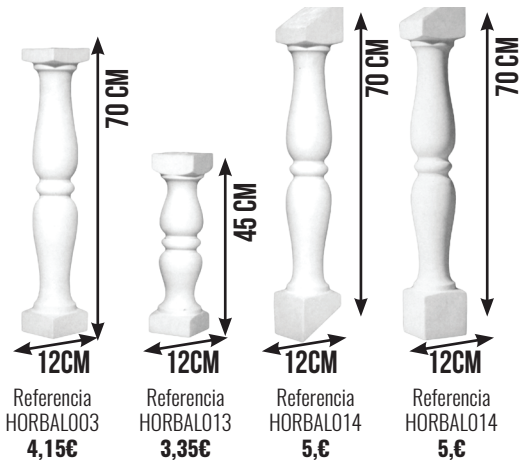

BALAUSTRE ROMA

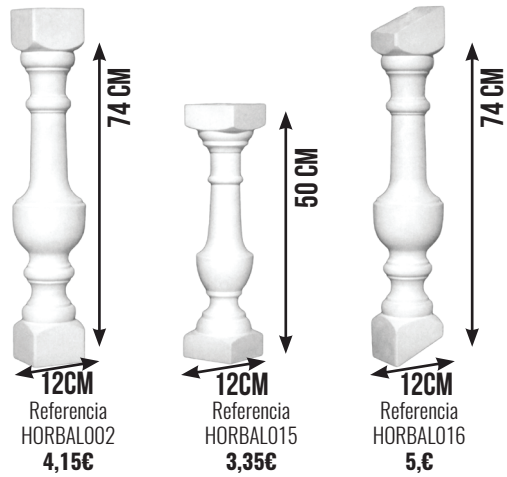

BALAUSTRE MÁLAGA

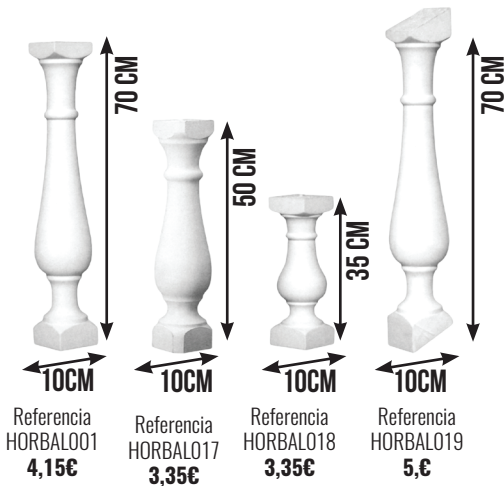

BALAUSTRE ATENAS

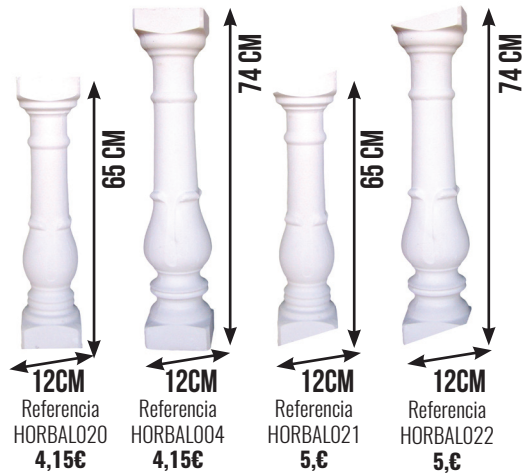

BALAUSTRE FLORAL

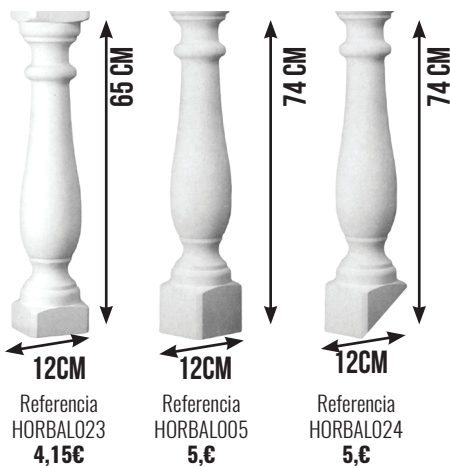

BALAUSTRE ALHAMBRA

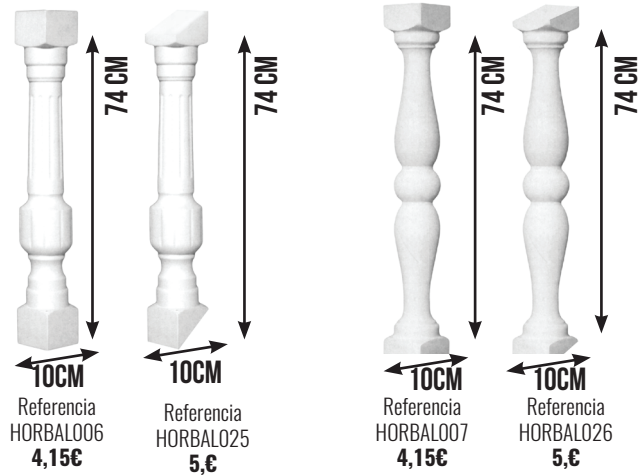

BALAUSTRE GRANADA

BALAUSTRE CÓRDOBA

PIEZAS PARA BALAUSTRADA

¿Necesita instalación? consúltenos, disponemos de personal especializado.

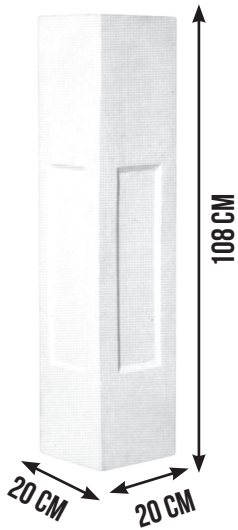

PILAR CUADRADO
Referencia HORBAL008
27,37€



PASAMANOS
Referencia HORBAL011
5,€



BASE ALTA
Referencia HORBAL010
5,€



BASE BAJA
Referencia HORBAL009
5,€

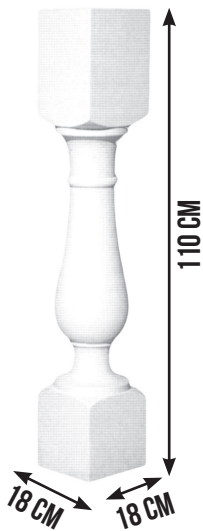

PILAR TALLADO
Referencia HORBAL012
48,€

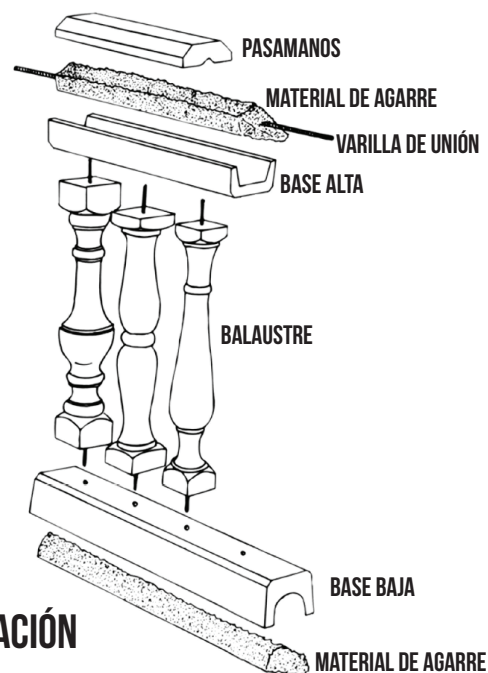

SISTEMA DE COLOCACIÓN

BALAUSTRADA IMITACIÓN MADERA

BALAUSTRADA MADERA CUADRADO

DESCRIPCIÓN	REFERENCIA	PRECIO
Metro lineal 98 cm	HORBAL143	47,00 €
NÚMERO DE PIEZAS		
1 BASE BAJA, 5 BALAUSTRAS, 1 PASAMANOS		



PILARES NO INCLUIDOS

BALAUSTRADA MADERA TRONCO

DESCRIPCIÓN	REFERENCIA	PRECIO
Metro lineal 98 cm	HORBAL168	47,00 €
NÚMERO DE PIEZAS		
1 BASE BAJA, 5 BALAUSTRAS, 1 PASAMANOS		



PILARES NO INCLUIDOS

BALAUSTRADA MADERA TORNEADA

DESCRIPCIÓN	REFERENCIA	PRECIO
Metro lineal 98 cm	HORBAL169	47,00 €
NÚMERO DE PIEZAS		
1 BASE BAJA, 5 BALAUSTRAS, 1 PASAMANOS		



PILARES NO INCLUIDOS

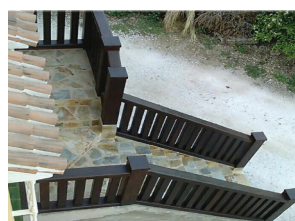

BALAUSTRES IMITACIÓN MADERA



PILAR REDONDO
Referencia HORBAL 176
55,00€

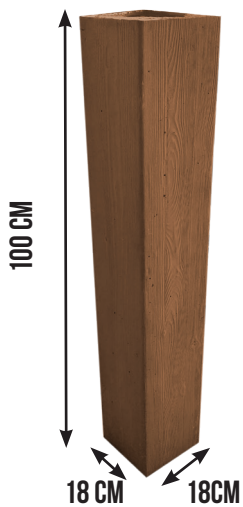

PILAR CUADRADO
Referencia HORBAL137
55,00€

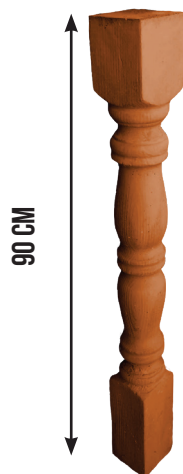

BALAUSTRE ESCALERA
Referencia HORBAL133
10,00€



BALAUSTRE ESCALERA CUADRADO
Referencia HORBAL132
10,00€



BALAUSTRE TRONCO
Referencia HORBAL134
10,00€



PASAMANOS Y BASE
Referencia HORBAL135
12,00€



BALAUSTRADA MODELO TRONCO

TERMINACIONES IMITACIÓN MADERA



CABEZA DE CABALLO GRANDE
Referencia HORBAL027
35,00€



CABEZA DE CABALLO PEQUEÑA
Referencia HORBAL065
24,00€

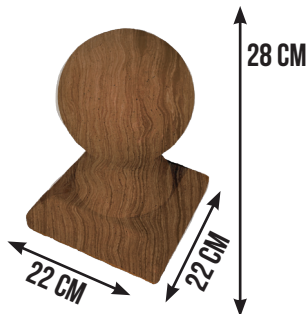

BOLA IMITACIÓN MADERA
Referencia HORBAL140
18,00€

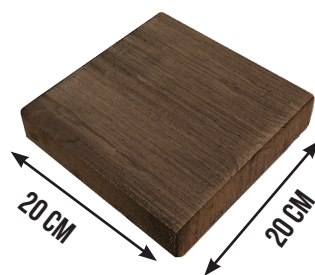

TERMINACIÓN IMITACIÓN MADERA
Referencia HORBAL138
15,00€

BALAUSTRADA RÚSTICA

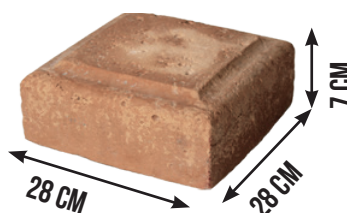

Remate pilar rústico
BLANCO HORBAL 130 13€
COLOR HOBAL 131 14€

GAMA DE COLORES

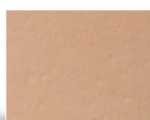

MARRÓN

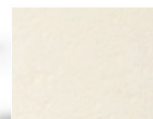

BLANCO

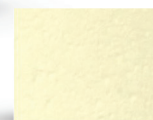

OCRE



BASE Y PASAMANO RÚSTICO
HORBAL 124 BLANCO 8€
HORBAL 125 COLOR 9€

BALAUSTRÉ RÚSTICO
HORBAL 120 BLANCO 6,50€
HORBAL 121 COLOR 7,20€



BALAUSTRÉ RÚSTICO

DESCRIPCIÓN	REFERENCIA	PRECIO
Metro lineal en blanco	HORBAL126	37,40 €
Metro lineal en color	HORBAL127	42,00 €
NÚMERO DE PIEZAS		
1 BASE BAJA, 4 BALAUSTRÉS, 1 PASAMANOS		

PILAR RÚSTICO
HORBAL 126 BLANCO 46€
HORBAL 127 COLOR 51€

PILARES NO INCLUIDOS

CORONACIONES

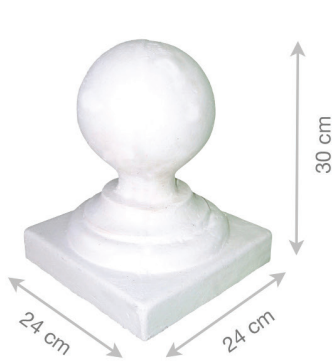

BOLA PEQUEÑA
HORBAL 034
10€

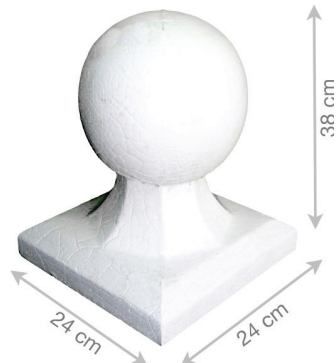

BOLA MEDIANA
HORBAL 035
10€

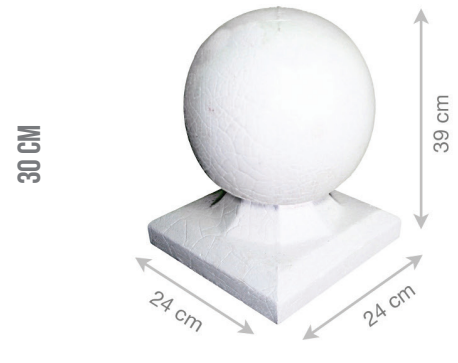

BOLA GRANDE
HORBAL 032
10€

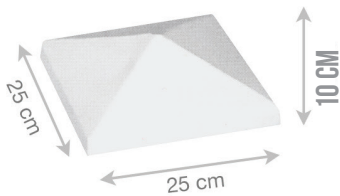

PIRÁMIDE PEQUEÑA
HORBAL 039
6,50€

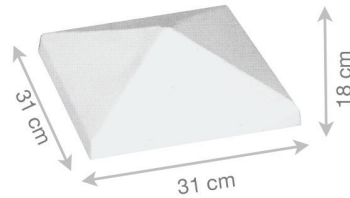

PIRÁMIDE MEDIANA
HORBAL 040
8,35€

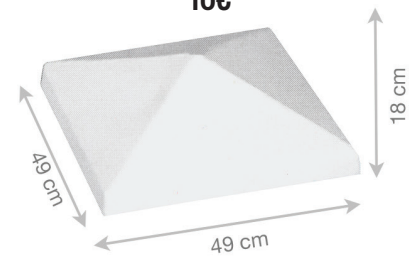

PIRÁMIDE GRANDE
HORBAL 041
20€

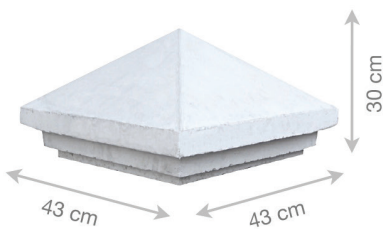

PIRÁMIDE 2 PLINTOS
HORBAL 038
16,50€



PIRÁMIDE CORONACIÓN
HORBAL 173
16,50€

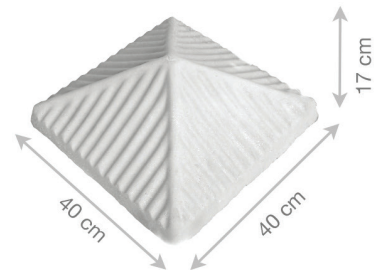

PIRÁMIDE RALLADA
HORBAL 037
16,50€



CORONACIONES



CABEZA DE CABALLO
Referencia HORBAL 027
25,00€



CABEZA DE CABALLO PEQUEÑA
Referencia HORDEC 186
20,00€



VENECIA
Referencia HORBAL 030
16,50€



GRANADA
Referencia HORBAL 031
10,00€



BELLOTA
Referencia HORBAL 036
10,00€

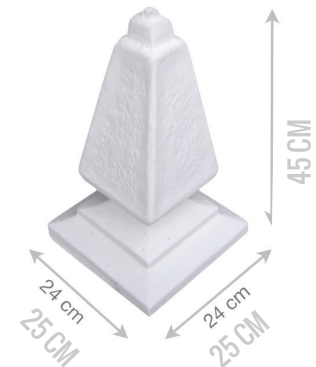

OBELISCO
Referencia HORBAL 065
10,00€

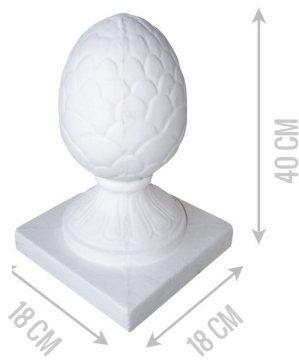

PIÑA GRANDE
Referencia HORBAL 175
10,00€



PIÑA
Referencia HORBAL 033
10,00€



PINÁCULO
Referencia HORBAL 029
10,00€



BARANDAS HORMIGÓN

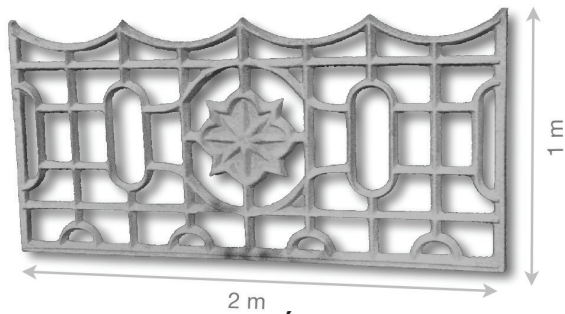

BARANDA MEDITERRÁNEO
HORDEC 001 150€

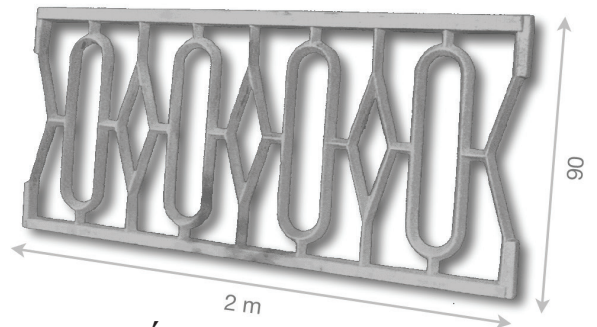

BARANDA PÉRSICO
HORDEC 005 133€

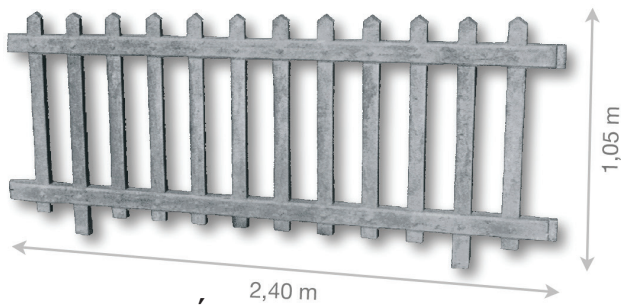

BARANDA PACÍFICO
HORDEC 002 150€

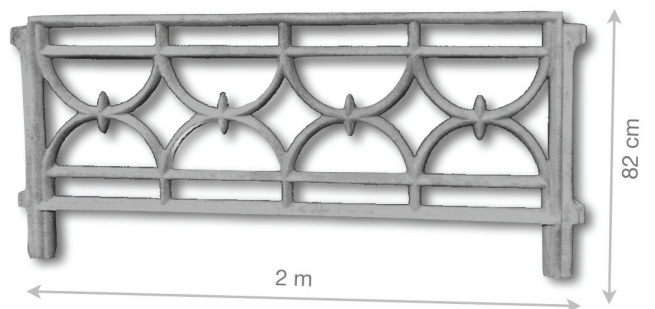

BARANDA ÍNDICO
HORDEC 006 142€



BARANDA ATLÁNTICO
HORDEC 003 150€

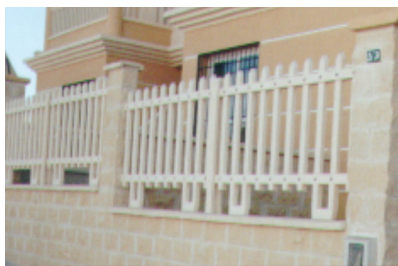
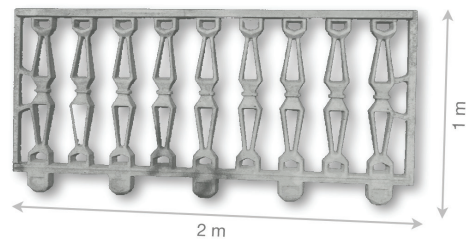

BARANDA BÁLTICO
HORDEC 004 150€

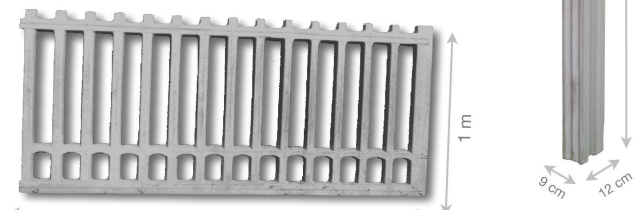

PILAR BARANDA
HORDEC 011 20€/ML

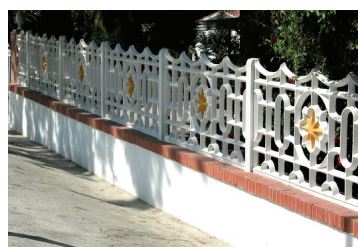

BARANDAS IMITACIÓN MADERA



MODELO MADERA NATURAL

PIEZA	REFERENCIA	PRECIO
BARANDA	HORDEC021	233€
PILAR 1,3 MT	HORDEC022	33€
ESCUADRA 1,3 M	HORDEC023	41 €



MODELO MADERA ENVEJECIDA

PIEZA	REFERENCIA	PRECIO
BARANDA	HORDEC008	233€
PILAR 1,3 MT	HORDEC019	33€
ESCUADRA 1,3 M	HORDEC020	41 €

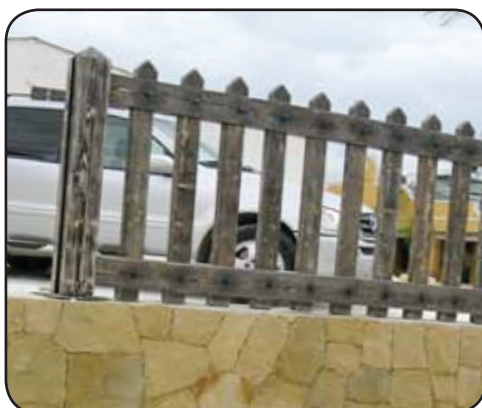

NOGAL OSCURO
PINO

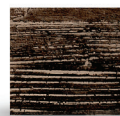

TEKA

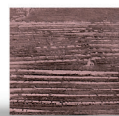

ROBLE



NEGRA

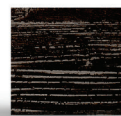

NEGRA
VETEADA



CUBREMUIROS Y PIEDRAS

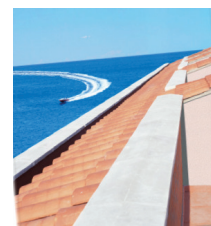
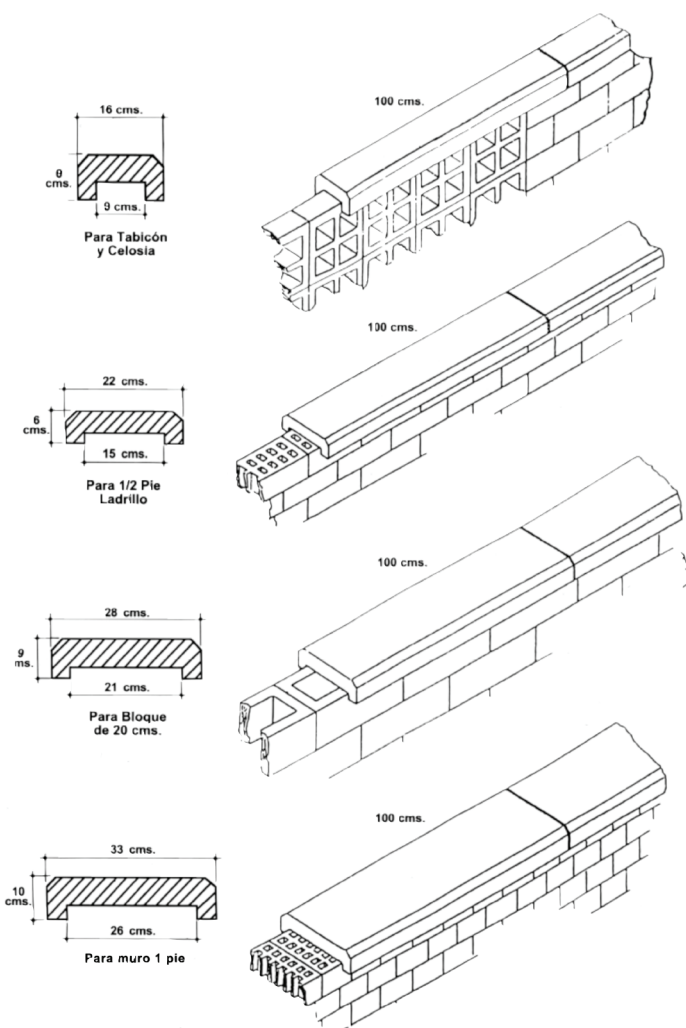
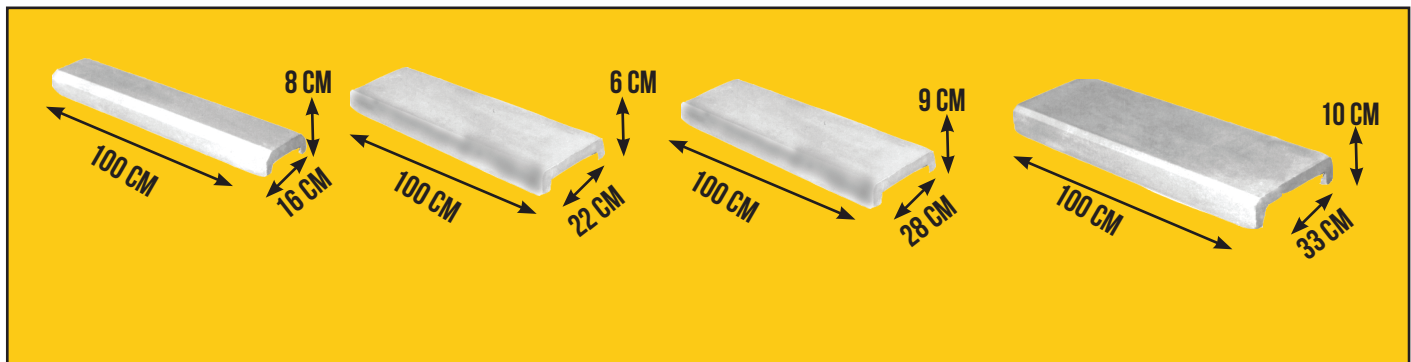

DESCRIPCIÓN	REFERENCIA	PRECIO
Piedra 30x4 cm	HORBAL60	28,00 €
Piedra a Medida	HORBAL59	41,75 €

* CONSULTE OTRAS MEDIDAS

PIEZAS PARA ALEROS Y VENTANAS

DESCRIPCIÓN	REFERENCIA	PRECIO
Peto Ventana	HORDEC 147	53,00 ML €

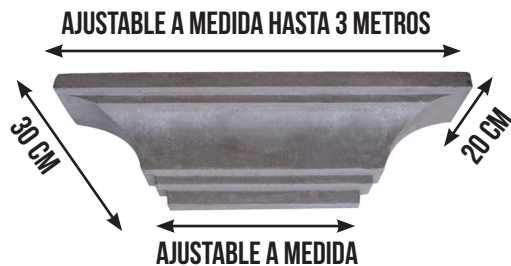

FABRICADO CON ARLITA

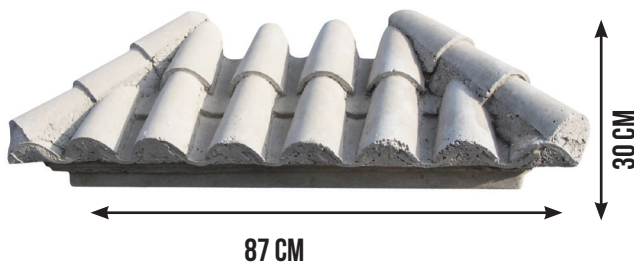

TEJADILLO VENTANA PEQUEÑO	REFERENCIA	PRECIO
GRIS	HORDEC 029	100€
BLANCO	HORDEC 031	108€

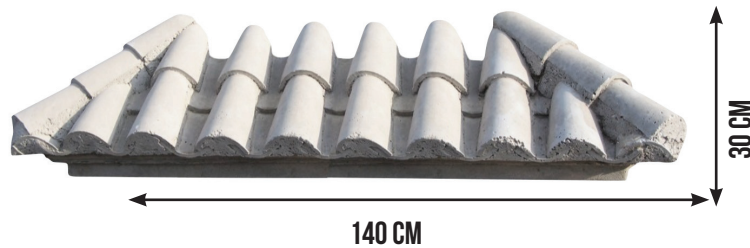

TEJADILLO VENTANA GRANDE	REFERENCIA	PRECIO
GRIS	HORDEC 030	109€



PIEZAS PARA ALEROS Y VENTANAS

PARTE SUPERIOR
 Referencia HORDEC 251
Alto: 0,61 mts.
Longitud placa más larga: 1,18 mts.
Largo placa inferior: 1,10 mts.
 ???€



PARTE INFERIOR
 Referencia HORDEC 251
Alto: 0,31 mts.
Largo parte superior 1,00 mts.
 ???€



PARTE SUPERIOR
Alto: 0,66 mts.
Longitud placa más larga: 1,27 mts.
Largo placa inferior: 1,15 mts.
 Referencia HORDEC 253
 ???€



PARTE INFERIOR
Alto: 0,51 mts.
Largo parte superior: 1,15 mts.
 Referencia HORDEC 254
 ???€

PARTE SUPERIOR
 Referencia HORDEC 251
Alto: 0,41 mts.
Longitud placa más larga: 1,20 mts.
Largo placa inferior: 1,10 mts.
 ???€



PARTE INFERIOR
 Referencia HORDEC 251
Alto: 0,41 mts.
Largo parte superior 1,10 mts.
 ???€

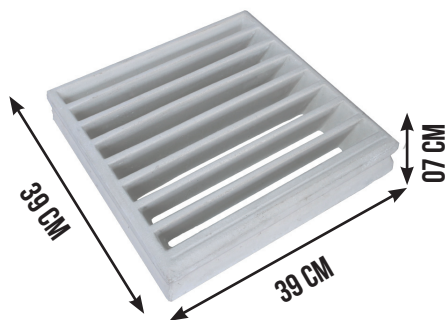

GÁRGOLAS
 Referencia HORBAL 062
08,35€

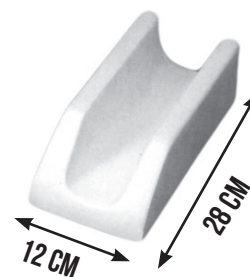

GÁRGOLAS
 Referencia HORBAL 061
06,50€

**FABRICAMOS GÁRGOLAS
 CON LAS MEDIDAS QUE NECESITE**

PIEZAS PARA ALEROS Y VENTANAS

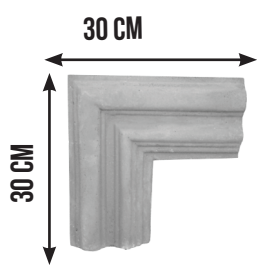

ESCUADRA RECERCADO 1
Referencia HORDEC 156
08,35€

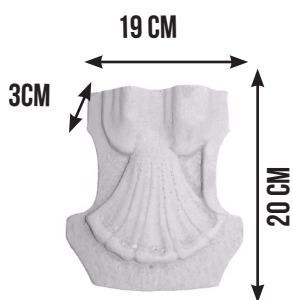

TERMINACIÓN RECERCADO CONCHA GRANDE
Referencia HORDEC 149
04,15€



TERMINACIÓN RECERCADO CONCHA PEQUEÑA
Referencia HORDEC 149
03,35€

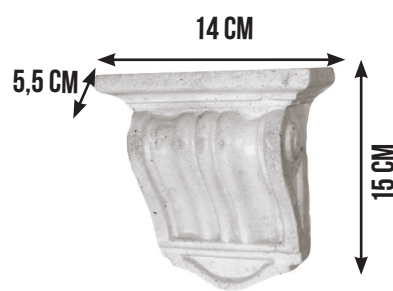

TERMINACIÓN RECERCADO
Referencia HORDEC 014
03,35€

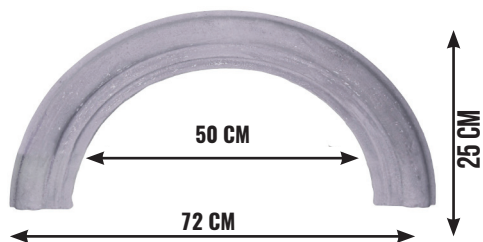

RECERCADO SEMICIRCULAR
Referencia HORDEC 154
13,50€

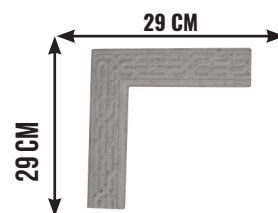

ESCUADRA RECERCADO 2
Referencia HORDEC 158
08,35€



RECERCADO 5
Referencia HORDEC 161
11,50€

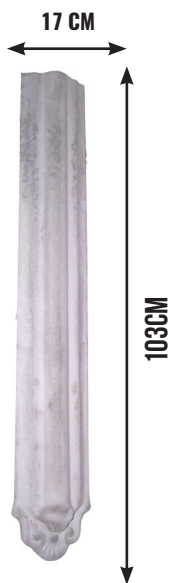

RECERCADO 3
Referencia HORDEC 159
11,50€



RECERCADO 2
Referencia HORDEC 157
11,50€



RECERCADO 1
Referencia HORDEC 155
11,50€

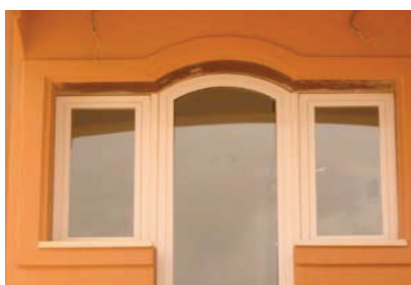

CHIMENEAS Y REMATES PARA PILARES

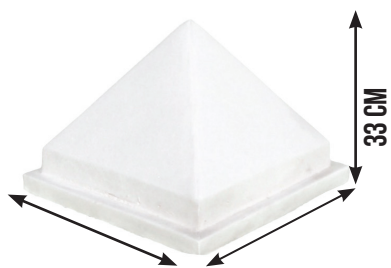

SOMBRERETE PIRÁMIDE
Referencia HORBAL 042
21,50€

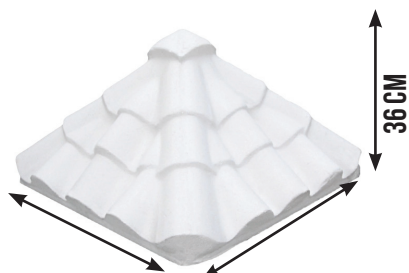

SOMBRERETE TEJADILLO
Referencia HORBAL 043
21,50€

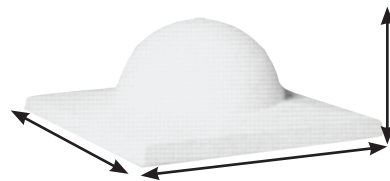

SOMBRERETE CIRCULAR
Referencia HORBAL 044
21,50€

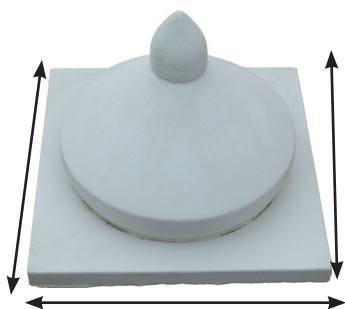

SOMBRERETE ???
Referencia HORBAL 0??
21,50€

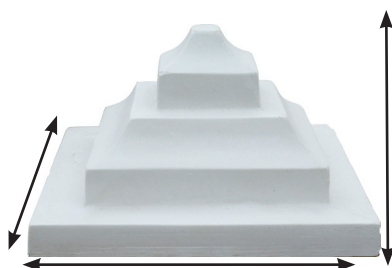

SOMBRERETE ???
Referencia HORBAL 0??
21,50€

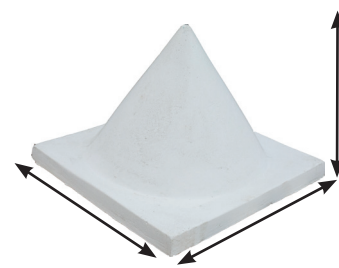

SOMBRERETE ???
Referencia HORBAL 0??
21,50€



SOMBRERETE ???
Referencia HORBAL 0??
21,50€

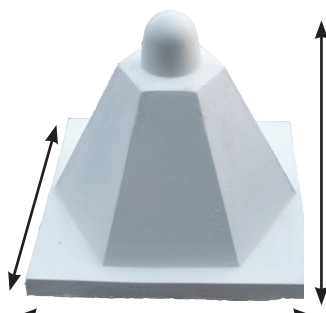

SOMBRERETE ???
Referencia HORBAL 0??
21,50€



FUSTE PALOS
Referencia HORBAL 045
30,00€

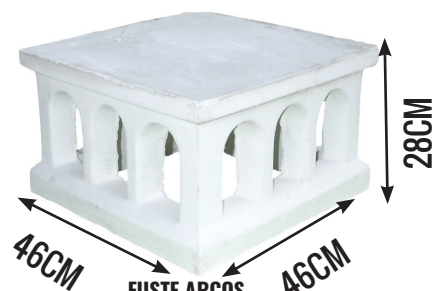

FUSTE ARCOS
Referencia HORBAL 046
30,00€

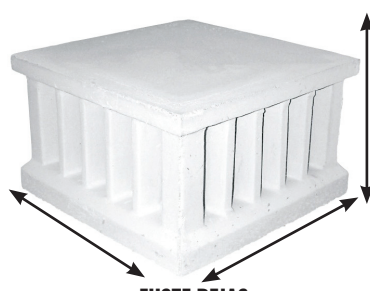

FUSTE REJAS
Referencia HORBAL 047
30,00€



FUSTE TRIANGULOS
Referencia HORBAL 048
53,00€

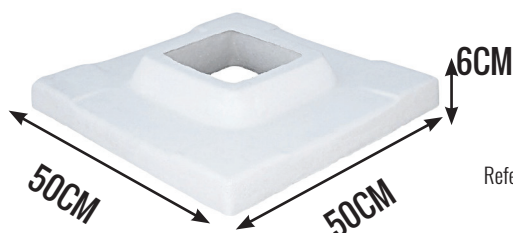

BASE
Referencia HORBAL 049
16,50€

BORDILLOS

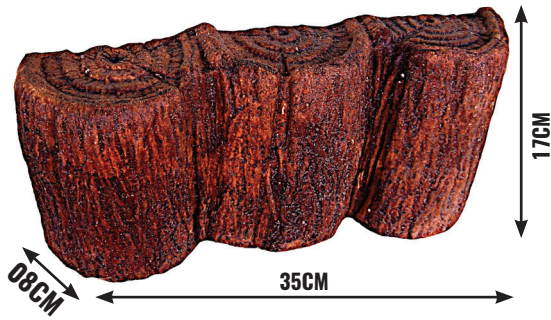

BORDILLO TRONCO DE MADERA
Referencia HORDEC 133
4,15€

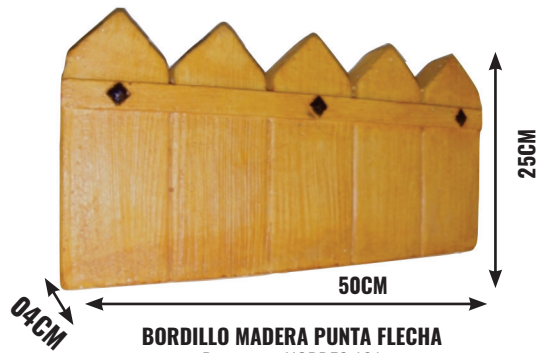

BORDILLO MADERA PUNTA FLECHA
Referencia HORDEC 131
5,00€

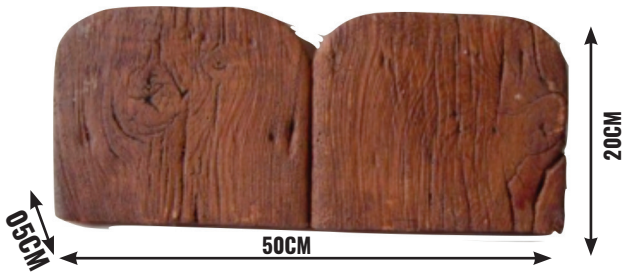

BORDILLO MADERA DOS TABLAS
Referencia HORDEC 130
5,00€



BORDILLO PALOS DE MADERA
Referencia HORDEC 132
6,00€



BORDILLO ONDULADO JARDÍN RECTO BLANCO
Referencia HORDEC 134
3,35€



BORDILLO ONDULADO CIRCULAR BLANCO
Referencia HORDEC 135
6,35€



BORDILLO ONDULADO JARDÍN RECTO VERDE
Referencia HORDEC 138
4,15€



BORDILLO ONDULADO CIRCULAR RECTO VERDE
Referencia HORDEC 139
8,35€

BORDILLO ONDULADO JARDÍN RECTO ROJO
Referencia HORDEC 136
3,75€



BORDILLO ONDULADO CIRCULAR RECTO ROJO
Referencia HORDEC 137
6,50€



PISCINA Y JARDÍN

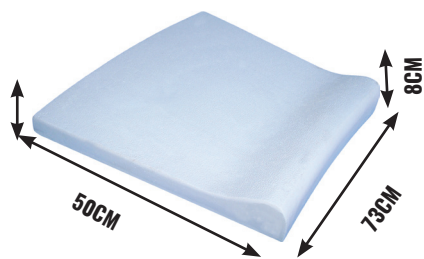

BORDE PISCINA
Referencia HORBAL 064
16,50€

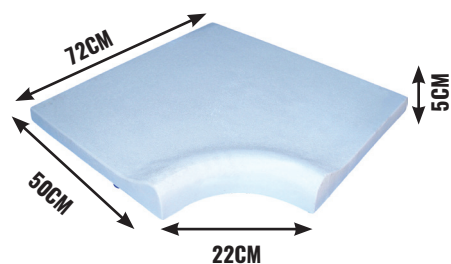

ESQUINA INTERIOR
Referencia HORBAL 066
20,00€

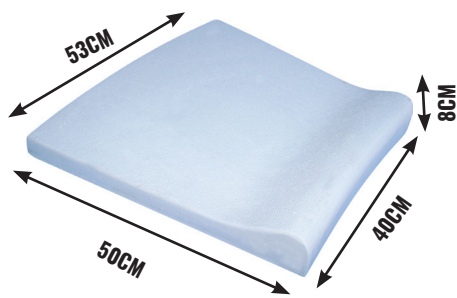

ESQUINA EXTERIOR
Referencia HORBAL 067
20,00€

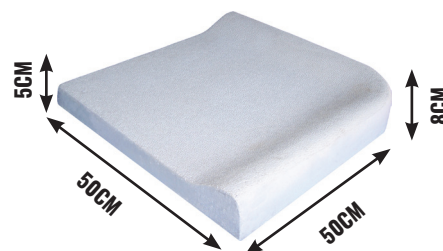

RADIO PARA MEDIO PUNTO DE 1,50
Referencia HORBAL 068
20,00€



BORDE PISCINA IMITACIÓN MADERA
Referencia HORDEC 182
21,00€

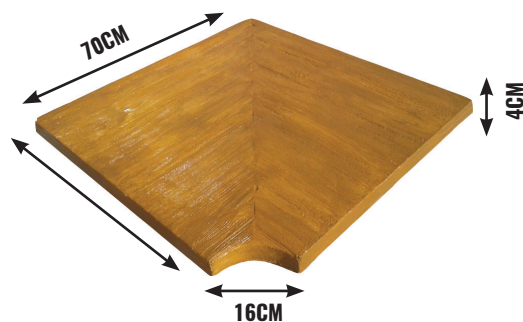

ESQUINA INTERIOR IMITACIÓN MADERA
Referencia HORDEC 183
25,00€



ESQUINA INTERIOR IMITACIÓN MADERA
Referencia HORDEC 184
25,00€



RADIO MEDIO PUNTO IMITACIÓN MADERA
Referencia HORDEC 184
25,00€

PISCINA Y JARDÍN

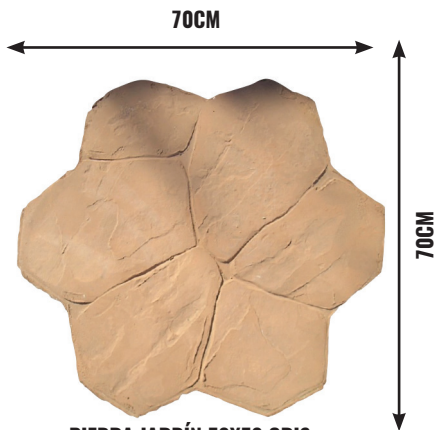

PIEDRA JARDÍN 70X70 GRIS
Referencia HORDEC 144 **10€/GRIS**
Referencia HORDEC 145 **17,50€/COLOR**



BORDE PISCINA IMITACIÓN MADERA
Referencia HORDEC 182

**PERSONALIZAMOS
EL COLOR
EN BORDES
DE PISCINA**



PLATO DUCHA
Referencia HORBAL 063
83,00€

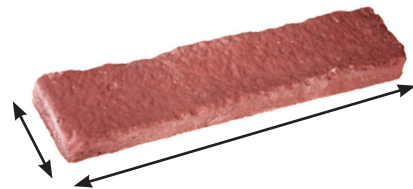

PLAQUETA RÚSTICO EN HORMIGÓN
Referencia HORDEC 195
0,20€

HORMIGÓN IMITACIÓN MADERA



ZÓCALO IMITACIÓN CAÑA

Referencia HORDEC177

24,€



REMATE PILAR TRONCO

Referencia HORDEC177

15,€



PELDAÑO IMITACIÓN MADERA

Referencia HORDEC175

31,€



PILAR IMITACIÓN TRONCO

Referencia HORDEC178

300,€



PILAR IMITACIÓN MADERA

Referencia HORDEC061

300,€

PISCINA Y JARDÍN

TRAVIESA GRANDE
Referencia HORDEC 189
40,00€



TRAVIESA PEQUÑA
Referencia HORDEC 234
26,90€

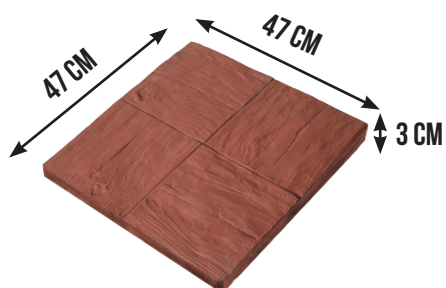

LOSA IMITACIÓN MADERA
47X47CM
Referencia HORDEC191
5,50€

SOMBRILLA HIERRO
CON BREZO NACIONAL 2MTX5CM
Referencia FERJAR014
93,70€

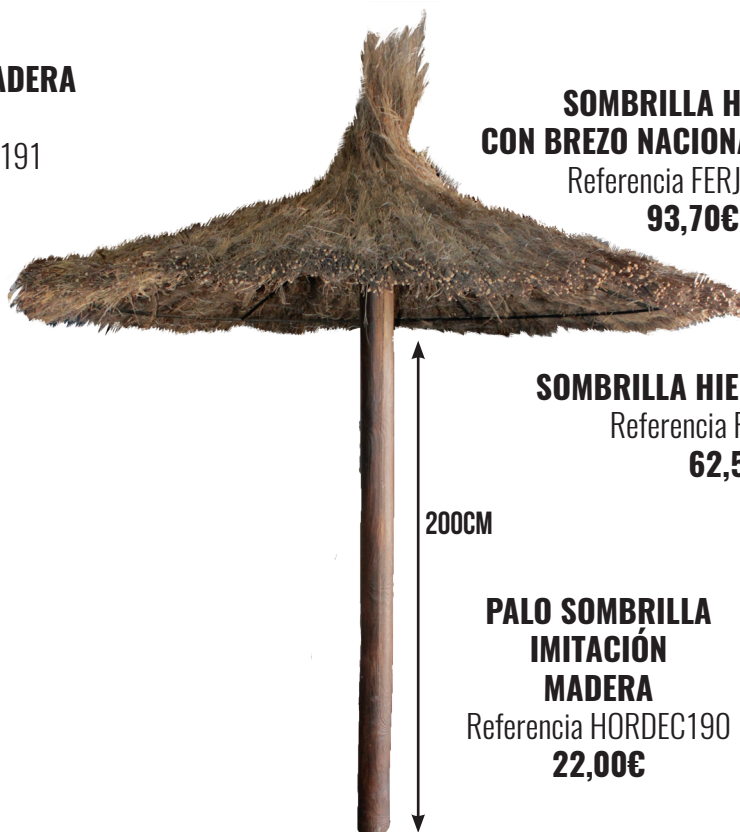

SOMBRILLA HIERRO 2 METROS
Referencia FERJAR013
62,50€

PALO SOMBRILLA
IMITACIÓN
MADERA
Referencia HORDEC190
22,00€

PISCINA Y JARDÍN



**CELOSÍA VENTILACIÓN
BLANCO**
Referencia HORBAL 141
08,35€

**CELOSÍA VENTILACIÓN
COLOR**
Referencia HORBAL 141
10,00€

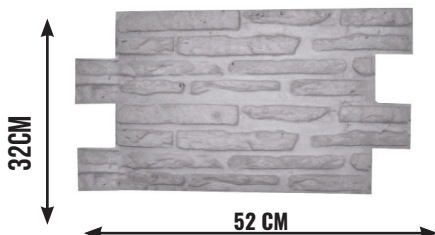

FRISO PARED PIEDRA BAJA
Referencia HORDEC 162
06,50€

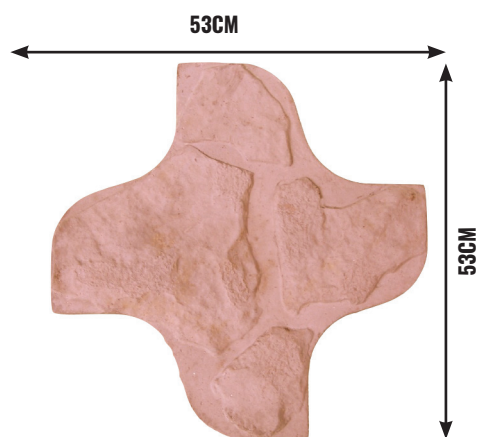

PIEDRA JARDÍN 53X53 GRIS
Referencia HORDEC 142 **3,35€/GRIS**
Referencia HORDEC 143 **3,35€/COLOR**

REVESTIMIENTO PIEDRA SALAMANCA

PILAS PARA LAVAR

CUERPO

TERMINACIÓN	REFERENCIA	PRECIO
BLANCO	HORBAL 050	41,50€
COLOR ROJO, MARRÓN, ALBERO	HORBAL 052	45€
ALICATADA GRESITE	HORBAL 054	58 €

BASE

TERMINACIÓN	REFERENCIA	PRECIO
BLANCO	HORBAL 051	25€
COLOR ROJO, MARRÓN, ALBERO	HORBAL 053	28€

PILA CUADRADA

TERMINACIÓN	REFERENCIA	PRECIO
BLANCO	HORBAL 116	31,25€
COLOR ROJO, MARRÓN, ALBERO	HORBAL	0€

**Terminaciones
BLANCO, ROJO, ALBERO, MARRÓN Y ALICATADA**

COLUMNAS Y PILARES



COLUMNAS Y PILARES

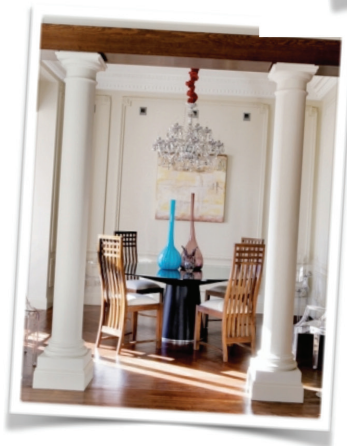
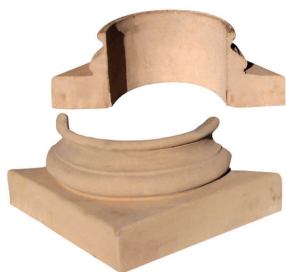

COLUMNAS Y PILARES



COLUMNA ESTRIADA DE 30 CON CAPITEL DE HOJAS
FUSTE ALTO: 2,50 mts.
BASE H: 0,18 ANCHO: 045X045
CAPITEL ALTO: 0,45 ANCHO: 0,50 X 0,50 ALTO TOTAL: 3,13
 Referencia HORDECO 267
???

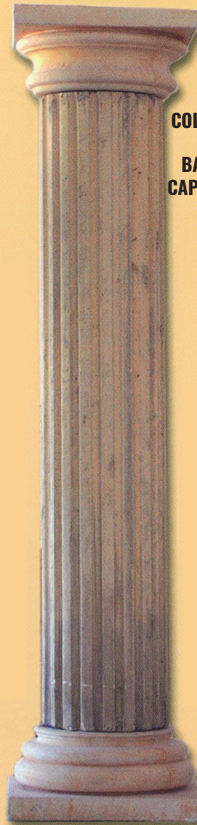

COLUMNA ESTRIADA DE 30 SIMPLE
FUSTE ALTO: 2,50 mts.
BASE H: 0,18 ANCHO: 045X045
CAPITEL ALTO: 0,19 ANCHO: 0,42 X 0,42 ALTO TOTAL: 2,87
 Referencia HORDECO 273
???

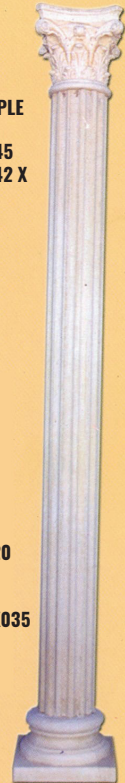

COLUMNA ESTRIADA DE 20 CON CAPITEL HOJAS
FUSTE ALTO: 2,20 mts.
BASE H: 0,20 ANCHO: 035X035
ALTO TOTAL: 2,70
PESO APROX.: 210KG.
 Referencia HORDEC 274
???

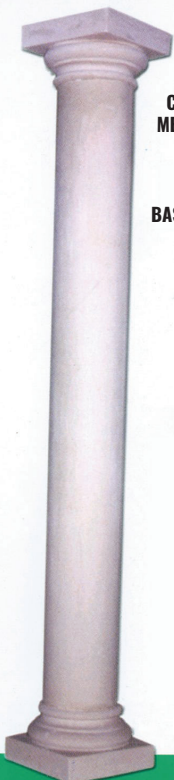

COLUMNA LISA DE MAYOR A MENOR DE 30 (INFERIOR) A 25 (SUPERIOR)
FUSTE ALTO: 2,10 mts.
BASE H: 0,25 ANCHO: 043X043
CAPITEL ALTO: 0,35
ANCHO: 0,43 X 0,43
ALTO TOTAL: 2,70 MTS.
PESO APROX.: 250 KG.
 Referencia HORDEC 268
???

COLUMNA LISA DE 30
FUSTE ALTO: 2,50 mts.
BASE H: 0,25 ANCHO: 043X043
CAPITEL ALTO: 0,25
ANCHO: 0,43 X 0,43
ALTO TOTAL: 3 MTS.
PESO APROX.: 400 KG.
 Referencia HORDEC 269
???



COLUMNA TRENZADA DE 20 SIMPLE
FUSTE ALTO: 2,20 mts.
BASE H: 0,22
ANCHO: 035X035
CAPITEL ALTO: 0,20
ANCHO: 0,35 X 0,35
ALTO TOTAL: 2,60 MTS.
PESO APROX.: 200 KG.
 Referencia HORDEC 270
???



COLUMNA TRENZADA DE 20 CON CAPITEL DE HOJAS
FUSTE ALTO: 2,20 mts.
BASE H: 0,20
ANCHO: 035X035
CAPITEL ALTO: 0,30
ANCHO: 0,35 X 0,35
ALTO TOTAL: 2,60 MTS.
PESO APROX.: 210 KG.
 Referencia HORDEC 271
???

COLUMNA ESTRIADA DE 20 SIMPLE MISMAS MEDIDAS QUE COLUMNA TRENZADA SIMPLE
 Referencia HORDEC 272
???

COLUMNAS Y PILARES



COLUMNA ÁRABE GRANDE DE 21
 FUSTE ALTO: 2,00 mts.
 BASE H: 0,30
 ANCHO: 036X036
 CAPITEL ALTO: 0,35
 ANCHO: 0,35 X 0,35
 ALTO TOTAL: 2,65
 PESO APROX.: 236KG.
 Referencia HORDEC 275
 ???€



COLUMNA ÁRABE PEQUEÑA CON CAPITEL NUEVO
 FUSTE ALTO: 0,41 mts.
 BASE H: 0,10
 ANCHO: 019X019
 CAPITEL ALTO: 0,26
 ANCHO: 0,17 X 0,17
 ALTO TOTAL: 0,76
 PESO APROX.: 14KG.
 Referencia HORDEC 276



COLUMNA ÁRABE PEQUEÑA MISMAS MEDIDAS QUE HODEC SALVO EL SUPLEMENTO
 ALTURA: 0,18 MTS.
 Referencia HORDECO 278
 ???€



COLUMNA ÁRABE PEQUEÑA
 FUSTE ALTO: 0,41 mts.
 BASE H: 0,10
 ANCHO: 019X019
 CAPITEL ALTO: 0,26
 ANCHO: 0,17 X 0,17
 ALTO TOTAL: 0,76
 PESO APROX.: 14KG.
 Referencia HORDEC 278
 ???€

COLUMNA ÁRABE GRANDE DE 15 CON CAPITEL DE ARCOS
 FUSTE ALTO: 1,20 mts.
 BASE H: 0,20
 ANCHO: 027X027
 CAPITEL ALTO: 0,37
 ANCHO: 0,31 X 0,31
 ALTO TOTAL: 1,77
 PESO APROX.: 134KG.
 Referencia HORDEC 279



COLUMNA ÁRABE GRANDE DE 15 CON CAPITEL DE ARCOS
 ALTO TOTAL: 2,57
 Referencia HORDEC 280
 ???€

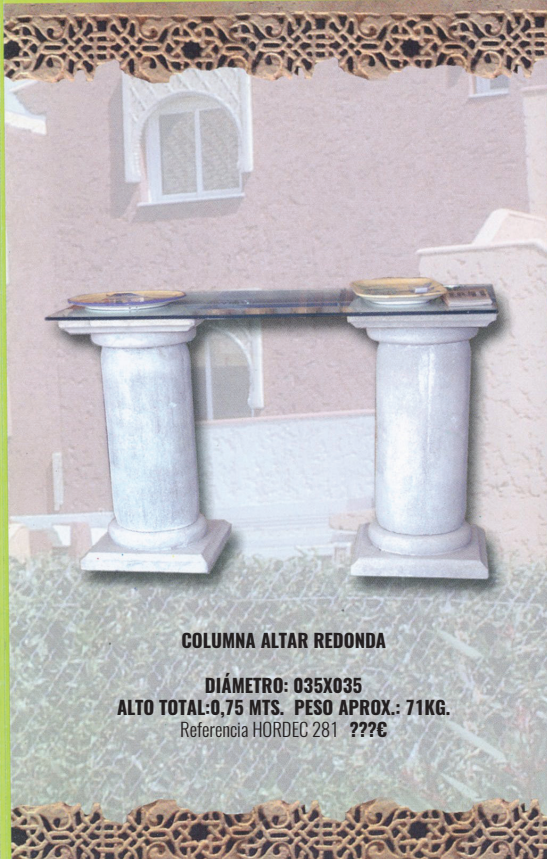

COLUMNA ALTAR REDONDA
 DIÁMETRO: 035X035
 ALTO TOTAL: 0,75 MTS. PESO APROX.: 71KG.
 Referencia HORDEC 281
 ???€



COLUMNA ÁRABE GRANDE DE 15
 FUSTE ALTO: 1,20 mts. BASE H: 0,20
 ANCHO: 027X027 CAPITEL ALTO: 0,26 ANCHO: 0,25 X 0,25
 ALTO TOTAL: 1,66 MTS. PESO APROX.: 88KG.
 Referencia HORDEC 282
 ???€

COLUMNA ÁRABE GRANDE DE 15
 ALTO TOTAL: 2,46 MTS. Referencia HORDEC 286
 ???€

COLUMNAS Y CELOSÍAS

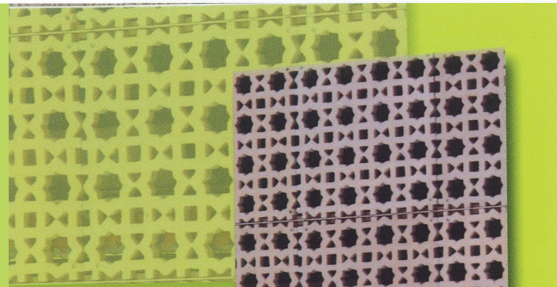

CELOSÍA ESTRELLAS
Medidas: 0,70x0,70
Peso: 18 kg.
Referencia HORDEC ???
???



CELOSÍA
Alto: 0,97 mts.
Ancho: 0,28 mts.
Peso: 18 kg.
Referencia HORDEC ???
???



CELOSÍA
Alto: 1,06 mts. Ancho: 0,28 mts.
Peso: 22 kg.
Referencia HORDEC ???
???

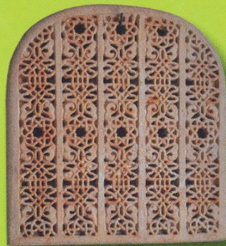

CELOSÍA
Alto: 0,61 mts. Ancho: 0,57 mts.
Peso: 7 kg.
Referencia HORDEC ???
???

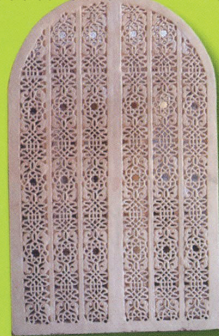

CELOSÍA
Alto: 1,17 mts. Ancho: 0,71 mts.
Peso: 35 kg.
Referencia HORDEC ???
???

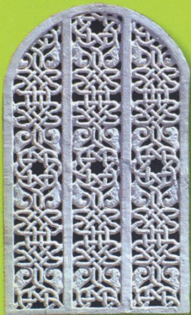

CELOSÍA
Alto: 0,59 mts. Ancho: 0,37 mts.
Peso: 7 kg.
Referencia HORDEC ???
???



CELOSÍA
Alto: 0,99 mts. Ancho: 0,60 mts.
Peso: 18 kg.
Referencia HORDEC ???
???



COLUMNA LISA DE 15
FUSTE ALTO: 1,20 mts.
BASE H: 0,20
ANCHO: 027X027
Referencia HORDECO 257
???

CAPITEL
BASE H: 0,20
ANCHO: 027X027
ALTURA TOTAL: 1,60 MTS.
PESO APROX.: 85 KG.
Referencia HORDEC 258
???

COLUMNA LISA DE 15
ALTURA TOTAL: 2,40 MTS.
Referencia HORDEC 259
???



COLUMNA LISA DE 12
BASE ANCHO 0,16 X 0,16
ALTURA TOTAL 1,46 MTS.
PESO APROX.: 120 KG.
Referencia HORDECO 265
???

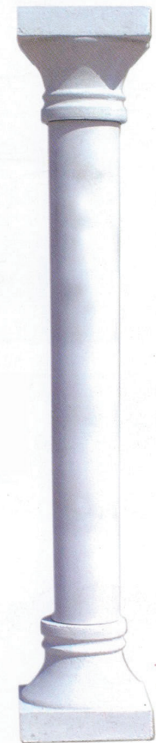

COLUMNA LISA 20
FUSTE H: 2,00
BASE H: 0,30
ANCHO: 036X036
CAPITEL H: 0,30
ANCHO: 036X036
ALTURA TOTAL: 2,60 MTS.
PESO APROX.: 182 KG.
Referencia HORDEC 260
???

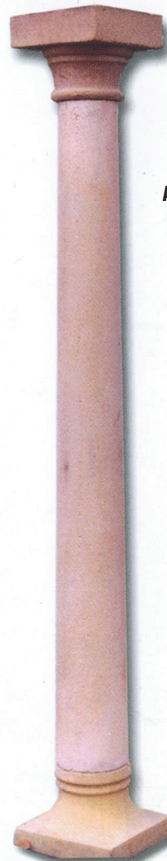

COLUMNA LISA DE MAYOR
A MENOR DE 18 (INFERIOR)
14 (SUPERIOR)
Referencia HORDEC 261
???

FUSTE
ALTO: 1,57
Referencia HORDEC 262
???

BASE
ALTO: 0,20
ANCHO: 0,25X0,25
ALTO TOTAL: 1,97
PESO APROX.: 120 KG.
Referencia HORDEC 264
???

COLUMNA LISA 10
FUSTE H: 0,41
BASE H: 0,10
ANCHO: 019X019
CAPITEL H: 0,10
ANCHO: 019X019
ALTURA TOTAL: 0,61 MTS.
PESO APROX.: 11 KG.
Referencia HORDEC 266
???



CELOSÍAS



TIRA ARABE
MEDIDAS 1,12MTS. X 0,42MTS.
GROSOR: 0,04
PESO: 42 KG.
 Referencia HORDEC ???
???



CORNISA ARABE
MEDIDAS 1,26MTS. X 0,40MTS.
PESO: 32 KG.
 Referencia HORDEC ???
???



MOLDURA CÓRDOBA HORIZONTAL 1
MEDIDAS 0,32MTS. X 1 MTS.
GROSOR: 0,04
PESO: 27 KG.
 Referencia HORDEC ???
???



MOLDURA CÓRDOBA HORIZONTAL 2
MEDIDAS 0,17 MTS. X 1 MTS.
GROSOR: 0,04
PESO: 17 KG.
 Referencia HORDEC ???
???

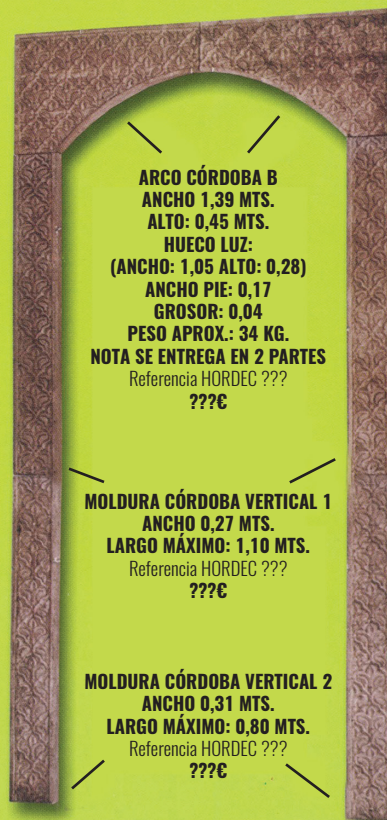

ARCO CÓRDOBA B
ANCHO 1,39 MTS.
ALTO: 0,45 MTS.
HUECO LUZ:
(ANCHO: 1,05 ALTO: 0,28)
ANCHO PIE: 0,17
GROSOR: 0,04
PESO APROX.: 34 KG.
NOTA SE ENTREGA EN 2 PARTES
 Referencia HORDEC ???
???

MOLDURA CÓRDOBA VERTICAL 1
ANCHO 0,27 MTS.
LARGO MÁXIMO: 1,10 MTS.
 Referencia HORDEC ???
???

MOLDURA CÓRDOBA VERTICAL 2
ANCHO 0,31 MTS.
LARGO MÁXIMO: 0,80 MTS.
 Referencia HORDEC ???
???



PLACA DE CISNES MEDIDAS 1,25 X 0,37 MTS. GROSOR: 0,35 MTS. PESO: 32 KG.
 Referencia HORDEC ??? **???**



APLACADO ARABE 2
MEDIDAS 0,53 X 0,30 MTS. GROSOR: 0,02 MTS.
PESO: 8 KG.
 Referencia HORDEC ??? **???**

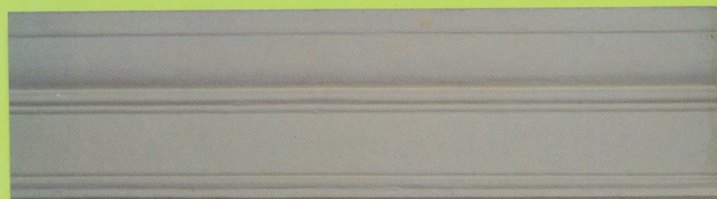

JAMBA GRANDE 0,22 X 1 MTS. PESO: 18 KG.
 Referencia HORDEC ??? **???**

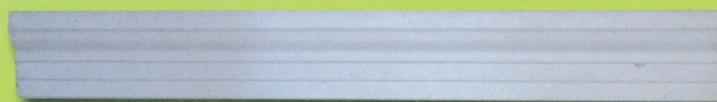

JAMBA PEQUEÑA 0,12 X 1 MTS. PESO: 10 KG.
 Referencia HORDEC ??? **???**



APLACADO ARABE 1
MEDIDAS 0,41 X 0,48 MTS. GROSOR: 0,03 MTS.
PESO: 14 KG.
 Referencia HORDEC ??? **???**



TIRA ARABE 0,16 X 1,12 MTS. GROSOR: 0,04 MTS. PESO: 13 KG.
 Referencia HORDEC ??? **???**

ARCOS ÁRABES



ARCO MODELO 14
ANCHO: 2,63 MTS. ALTO 1,20 MTS.
HUECO LUZ (ANCHO 2,31 ALTO 0,85)
ANCHO PIE: 0,16 MTS. GROSOR: 0,06 MTS.
PESO APROX. MACIZO: 140 KG.
PESO APROX. CALADO: 97 KG.
 Referencia HORDEC ???
???

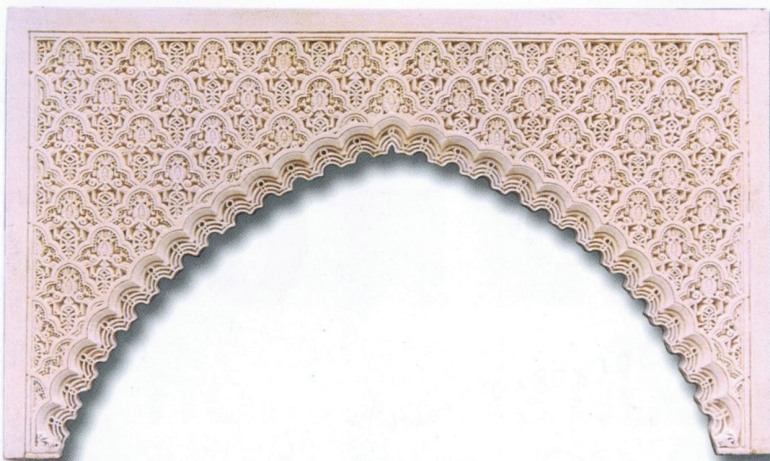

ARCO MODELO 14 B
ANCHO: 2,04 MTS. ALTO 1,20 MTS.
HUECO LUZ (ANCHO 1,75 ALTO 0,82)
ANCHO PIE: 0,15 MTS. GROSOR: 0,07 MTS.
PESO APROX. MACIZO: 183 KG.
PESO APROX. CALADO: 127 KG.
 Referencia HORDEC ???
???

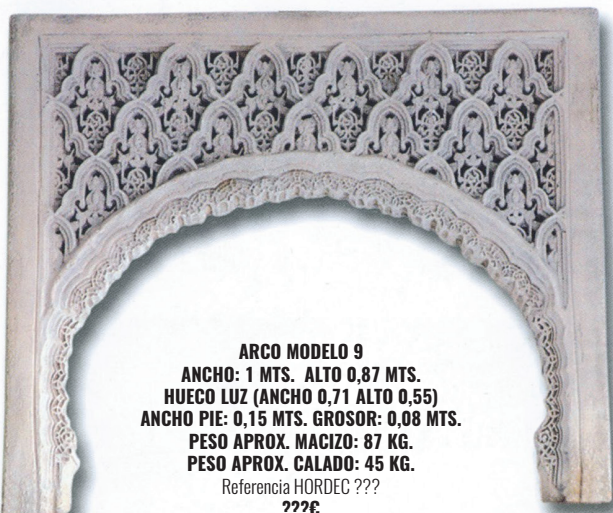

ARCO MODELO 9
ANCHO: 1 MTS. ALTO 0,87 MTS.
HUECO LUZ (ANCHO 0,71 ALTO 0,55)
ANCHO PIE: 0,15 MTS. GROSOR: 0,08 MTS.
PESO APROX. MACIZO: 87 KG.
PESO APROX. CALADO: 45 KG.
 Referencia HORDEC ???
???

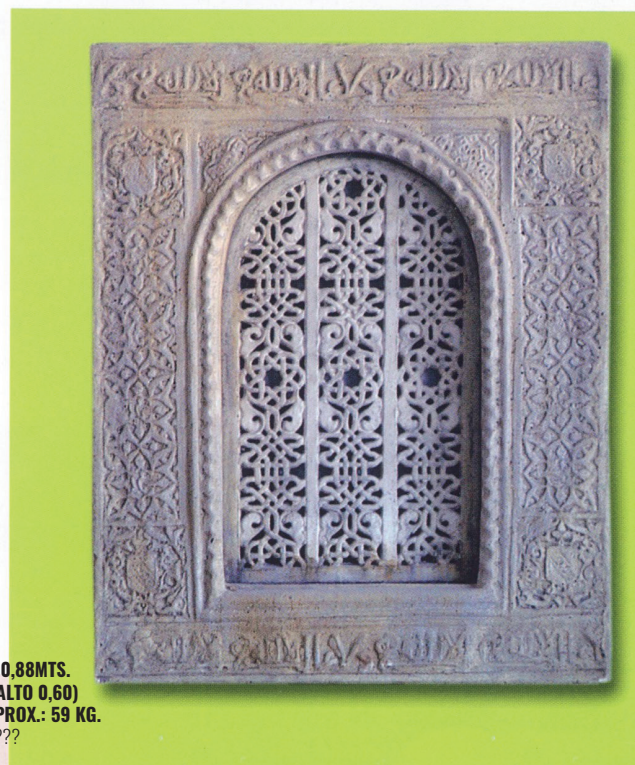

VENTANUCO
ANCHO: 0,71 MTS. ALTO 0,88 MTS.
HUECO LUZ (ANCHO 0,35 ALTO 0,60)
GROSOR: 0,05 MTS. PESO APROX.: 59 KG.
 Referencia HORDEC ???
???

ARCOS ÁRABES

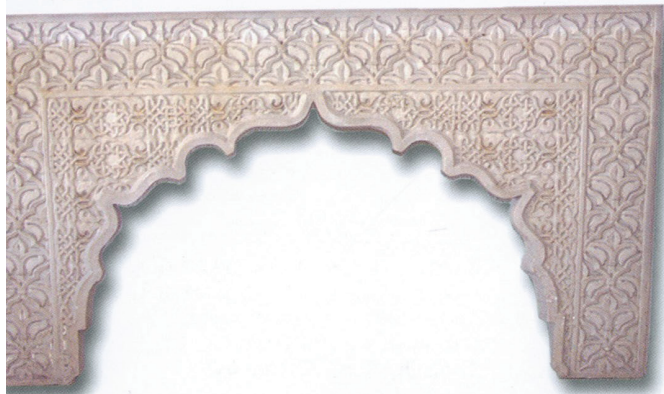

ARCO MODELO 12
ANCHO: 1,36 MTS. ALTO 0,76 MTS.
HUECO LUZ (ANCHO 0,96 ALTO 0,58)
ANCHO PIE: 0,17 MTS. GROSOR: 0,06 MTS.
PESO APROX.: 60 KG.
Referencia HORDEC ???
???

ARCO MODELO
ANCHO: 1,21 MTS. ALTO 0,60 MTS.
HUECO LUZ (ANCHO 0,87 ALTO 0,43)
ANCHO PIE: 0,17 MTS. GROSOR: 0,04 MTS.
PESO APROX.: 45 KG.
Referencia HORDEC ???
???



DISPONEMOS DE MÁS MEDIDAS EN ESTE MISMO MODELO.
CONSULTEN OTRAS OPCIONES EN NUESTRA PÁGINA WEB.



ARCO CÓRDOBA D
ANCHO: 2,29 MTS. ALTO 0,42 MTS. HUECO LUZ (ANCHO 1,95 ALTO 0,25)
ANCHO PIE: 0,17 MTS. GROSOR: 0,04 MTS.
PESO APROX.: 50 KG.
Referencia HORDEC ???
???



ARCO MODELO 17
ANCHO: 2,01 MTS. ALTO 0,69 MTS. HUECO LUZ (ANCHO 1,75 ALTO 0,41)
ANCHO PIE: 0,13 MTS. GROSOR: 0,09 MTS.
PESO APROX. MACIZO: 138 KG. PESO APROX. CALADO: 95 KG.
Referencia HORDEC ???
???

ARCOS ÁRABES

ARCO MODELO 8
ANCHO: 1 MTS. ALTO 0,56 MTS.
HUECO LUZ (ANCHO 0,36 ALTO 0,39)
ANCHO PIE: 0,08 MTS. GROSOR: 0,09 MTS.
PESO APROX. MACIZO: 63 KG.
PESO APROX. CALADO: 49 KG.
Referencia HORDEC ???
???



ARCO MODELO 13
ANCHO: 0,84 MTS. ALTO 0,68 MTS.
HUECO LUZ (ANCHO 0,66 ALTO 0,46)
ANCHO PIE: 0,09 MTS. GROSOR: 0,05 MTS.
PESO APROX. : 19 KG.
Referencia HORDEC ???
???



ARCO MODELO 11
ANCHO: 1,44 MTS. ALTO 1,28 MTS.
HUECO LUZ (ANCHO 1,12 ALTO 0,90)
ANCHO PIE: 0,08 MTS. GROSOR: 0,09 MTS.
PESO APROX. MACIZO: 152 KG.
PESO APROX. CALADO: 102 KG.
Referencia HORDEC ???
???

ARCOS ÁRABES



ARCO MODELO 2
ANCHO: 0,98 MTS. ALTO 0,97MTS.
HUECO LUZ (ANCHO 0,72 ALTO 0,80)
ANCHO PIE: 0,07 MTS. GROSOR: 0,09 MTS.
PESO APROX.: 70 KG.
 Referencia HORDEC ???
???



ARCO MODELO 10
ANCHO: 1,29 MTS. ALTO 0,91 MTS.
HUECO LUZ (ANCHO 1,03 ALTO 0,61)
ANCHO PIE: 0,13 MTS. GROSOR: 0,06 MTS.
PESO APROX. MACIZO: 112 KG.
PESO APROX. CALADO: 72 KG.
 Referencia HORDEC ???
???



ARCO MODELO 3
ANCHO: 2,04 MTS. ALTO 1,25 MTS.
HUECO LUZ (ANCHO 1,56 ALTO 0,99)
ANCHO PIE: 0,24 MTS. GROSOR: 0,06 MTS.
PESO APROX.: 140 KG.
 Referencia HORDEC ???
???

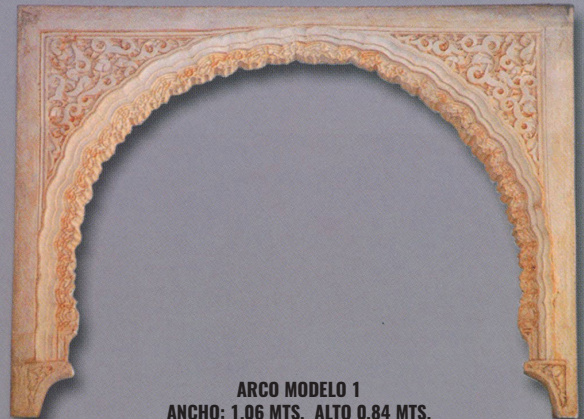

ARCO MODELO 1
ANCHO: 1,06 MTS. ALTO 0,84 MTS.
HUECO LUZ (ANCHO 0,84 ALTO 0,74)
ANCHO PIE: 0,35 MTS. GROSOR: 0,06 MTS.
PESO APROX.: 63 KG.
 Referencia HORDEC ???
???



ARCO MODELO 6
ANCHO: 1,03 MTS. ALTO 0,73 MTS.
HUECO LUZ (ANCHO 0,81 ALTO 0,61)
ANCHO PIE: 0,12 MTS. GROSOR: 0,22 MTS.
PESO APROX.: 68 KG.
PESO APROX. A DOS CARAS: 68KG.
 Referencia HORDEC ???
???

ARCOS ÁRABES



DETALLE COMPOSICIÓN EN URBANIZACIÓN
COLUMNA ÁRABE PEQUEÑA
Referencia HORDEC 284
???



DETALLE COMPOSICIÓN VENTANA
COLUMNA ÁRABE PEQUEÑA
Referencia HORDEC 285
???



ARCO MODELO HORDEC MACIZO
PESO APROX.: 40 KG. CALADO PESO APROX.: 26KG.
ANCHO 0,50 MTS. ALTO 0,80 MTS.
HUECO LUZ (ANCHO 0,38-ALTO 0,43)
ANCHO PIE: 0,06 GROSOR: 0,07
Referencia HORDEC 284
???



ARCO MODELO 4
ANCHO: 1,20 MTS. ALTO 1,13 MTS.
HUECO LUZ (ANCHO 0,76 ALTO 0,64)
ANCHO PIE: 0,22 MTS. GROSOR: 0,07 MTS.
PESO APROX. MACIZO: 160 KG.
PESO APROX. CALADO: 130 KG.
Referencia HORDEC ???
???

CONSTRUCCION

FIGURAS JARDÍN



ANGEL SENTADO GRANDE
REFERENCIA HORDEC192
62,50€

ANGEL SENTADO PEQUEÑO
REFERENCIA HORDEC191
35€



EMPERADOR 80X55CM
REFERENCIA HORDEC221
175€



ANGEL TUMBADO 27X37CM
REFERENCIA HORDEC198
25€



NIÑO JAPONÉS 63X25CM
REFERENCIA HORDEC215
62,50€



NIÑA JAPONESA 63X25CM
REFERENCIA HORDEC216
62,50€



MACETERO ÁNGELES 22X25CM
REFERENCIA HORDEC207
37,50€



EMPERADOR 80X55CM
REFERENCIA HORDEC217
175€



BUDA MEDITANDO 62X33CM
REFERENCIA HORDEC215
137,50€



CABEZA BUDA 68X30CM
REFERENCIA HORDEC218
175€



MACETERO ÁNGELES 32X35CM
REFERENCIA HORDEC206
62,50€



COLUMNA 48X30CM
REFERENCIA HORDEC223
62,50€

COLUMNAS Y PILARES



**COLUMNA RECTA
CAPITEL CUADRADO**
Referencia HORDEC 199 **195€-GRIS**
Referencia HORDEC 199 **215€-BLANCA**

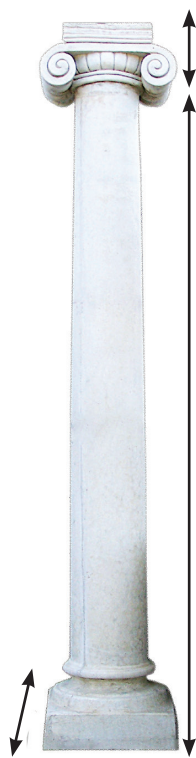

COLUMNA ROMANA
Referencia HORDEC 051 **334€-GRIS**
Referencia HORDEC 052 **367€-BLANCA**

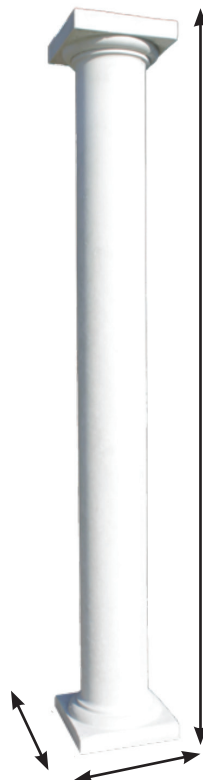

**COLUMNA RECTA
CAPITEL CUADRADO**
Referencia HORDEC 198 **225€-GRIS**
Referencia HORDEC 197 **250€-BLANCO**



**COLUMNA
CÓNICA GRANDE**
Referencia HORDEC 167 **267€-GRIS**



**COLUMNA
CÓNICA PEQUEÑA**
Referencia HORDEC 168 **183€-GRIS**



FIGURAS JARDÍN



BUDA DE LA SUERTE 35X22CM
REFERENCIA HORDEC195
87,50€



MOJE SHAOLIN 44X30CM
REFERENCIA HORDEC202
87,50€



BUDA GRANDE GRIS O TERRACOTA 40X60CM
REFERENCIA HORDEC193
87,50€



DIOSA GANESHA 23X19CM
REFERENCIA HORDEC196
55€



GUERRERO XIAN DE RODILLAS 55X30CM
REFERENCIA HORDEC219
137,50€



GUERRERO TERRACOTA 66X22CM
REFERENCIA HORDEC199
50€



BUDA PEQUEÑO 35X22CM
REFERENCIA HORDEC193
66,70€



GUERRERO XIAN 55X32CM
REFERENCIA HORDEC219
137,50€



BUDA DE LA SUERTE 35X22CM
REFERENCIA **HORDEC195**
87,50€



FAROLILLO TEMPLO CHINO 43X27CM
REFERENCIA HORDEC195
50€

PILAS PARA LAVAR

CUERPO

TERMINACIÓN	PRECIO	REFERENCIA
BLANCO	41.5€	HORBAL 050
COLOR ROJO, ALBERO, MARRÓN	45€	HORBAL 052
ALILCATADA GRESITE	58€	HORBAL 054

BASE

TERMINACIÓN	PRECIO	REFERENCIA
BLANCO	25€	HORBAL 051
COLOR ROJO, ALBERO, MARRÓN	28€	HORBAL 053

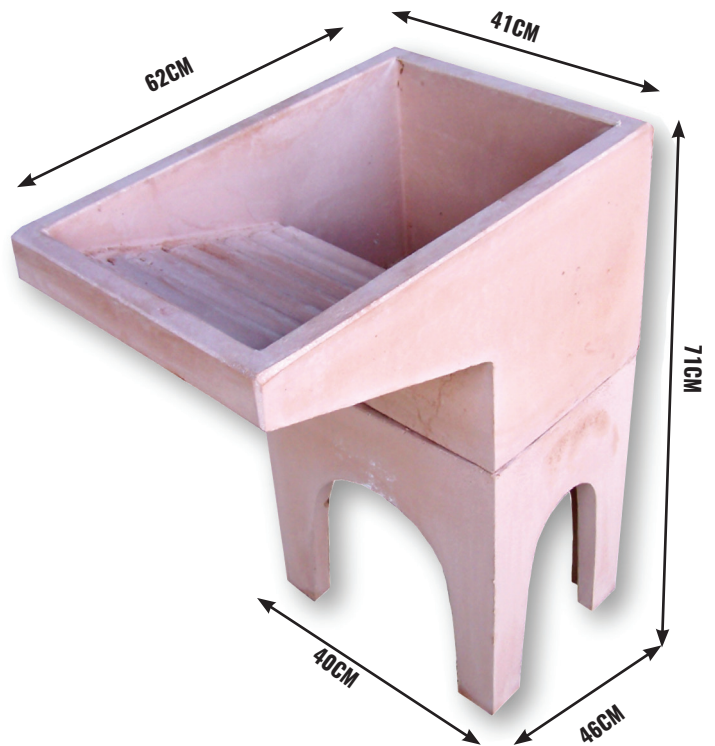

PILA CUADRADA

TERMINACIÓN	PRECIO	REFERENCIA
BLANCO	31,25€	HORBAL 116
COLOR ROJO, ALBERO, MARRÓN	39€	HORBAL 170

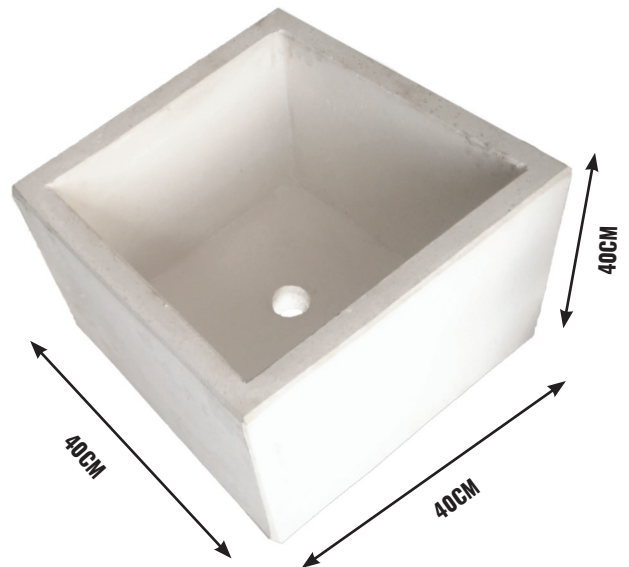

**TERMINACIONES:
BLANCO, ROJO, ALBERO, MARRÓN Y ALICATADA**

FIGURAS JARDÍN



Mano con PAJARO 20X25CM
REFERENCIA HORDEC200
30€



MONOS SABIOS 20X18CM
REFERENCIA HORDEC211
50€ UNIDAD



TORTUGA 20X25CM
REFERENCIA HORDEC190
20€ UNIDAD



MOCHUELO 17X12CM
REFERENCIA HORDEC200
17,50,€ UNIDAD



SURICATO PEQUEÑO
25X7CM
REFERENCIA HORDEC205
20€ UNIDAD



SURICATO MEDIANO
43X15CM
REFERENCIA HORDEC204
30€ UNIDAD



RANA POSANDO 37X17CM
REFERENCIA HORDEC220
30€ UNIDAD



LEON 57X25CM
REFERENCIA HORDEC210
100€ UNIDAD



RANA POSANDO 30X18CM
REFERENCIA HORDEC203
35€ UNIDAD



BULLDOG 42X30CM
REFERENCIA HORDEC214
87,50€ UNIDAD



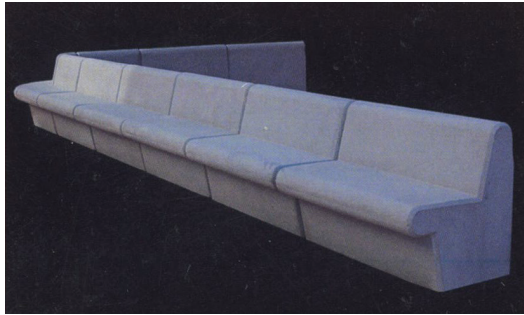

BANCO CUARZO 750KG.
REFERENCIA HORBAN006
268€



BANCO HEMALITE 271KG.
REFERENCIA HORBAN008
125€

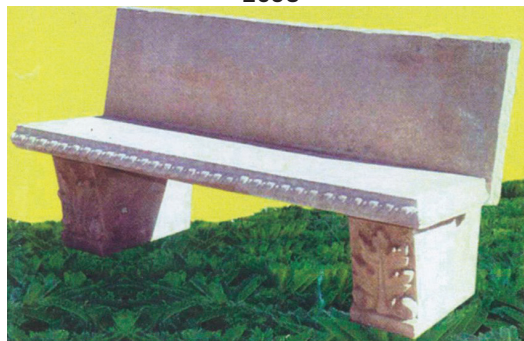

BANCO HEMALITE
REFERENCIA HORBAN00
€

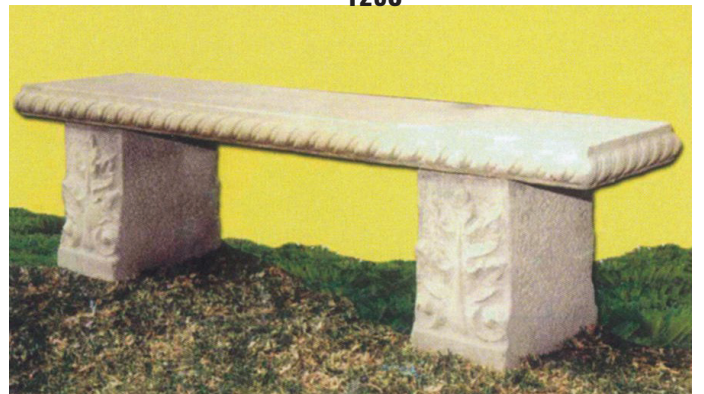

BANCO JARDÍN
REFERENCIA HORBAN00
€



BANCO MONVIEDRO 370KG.
REFERENCIA HORBAN005
180€



BANCO OTOÑO 280KG.
REFERENCIA HORBAN007
130€

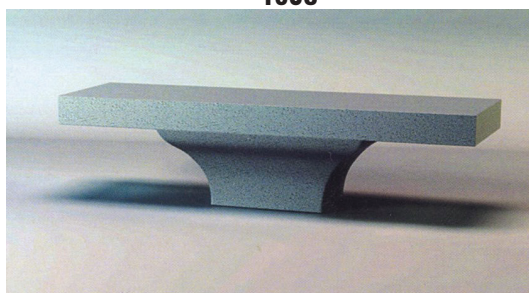

BANCO PIÉ CENTRAL SIN RESPALDO 415KG.
REFERENCIA HORBAN010
241€

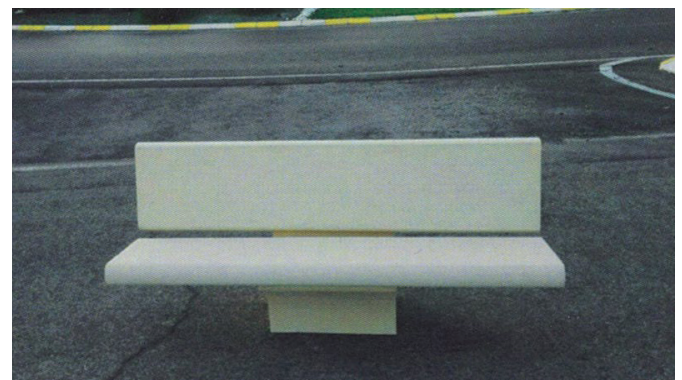

BANCO PIÉ CENTRAL CON RESPALDO 390KG.
REFERENCIA HORBAN009
250€



BANCO PLATA 400KG.
REFERENCIA HORBAN004
163€

JARDINERAS

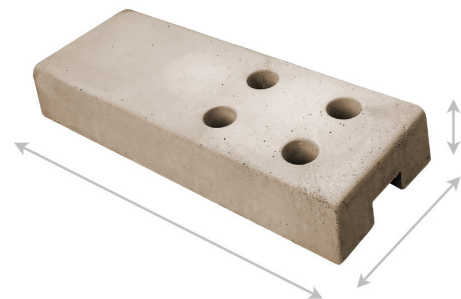
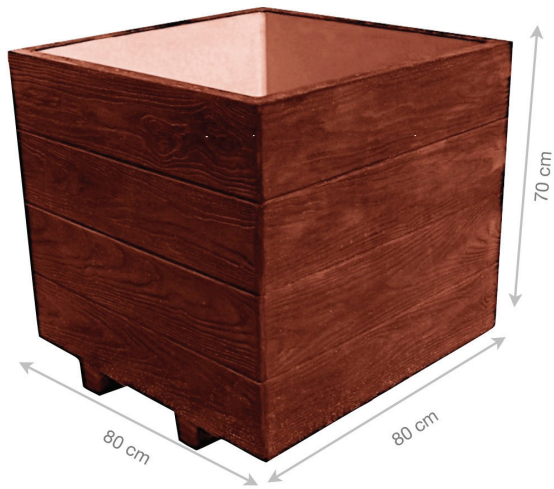

NOGAL
OSCURO

PINO

TEKA

ROBLE

NEGRA

NEGRA
VETEADA

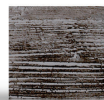
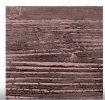

JARDINERAS



MACETERO GRANADA GRANDE
 DIÁMETRO 0,80 MTS. ALTURA 0,68 MTS
 PESO APROX.: 190 KG.
 Referencia HORDEC ???
 ???€

MACETERO GRANADA MEDIANO
 DIÁMETRO 0,65 MTS. ALTURA 0,51 MTS
 PESO APROX.: 86 KG.
 Referencia HORDEC ???
 ???€

MACETERO GRANADA PEQUEÑO
 DIÁMETRO 0,53 MTS. ALTURA 0,42 MTS
 PESO APROX.: 50 KG.
 Referencia HORDEC ???
 ???€



MACETERO PLÁTANOS
 DIÁMETRO 0,57 MTS. ALTURA 0,50 MTS
 BASE 0,30 X 0,30 MTS.
 PESO APROX.: 65 KG.
 Referencia HORDEC ???
 ???€



MACETERO VENECIA
 DIÁMETRO 1,20 MTS. BASE 0,63X 0,63 MTS. ALTURA 0,67 MTS
 PESO APROX.: 300 KG.
 Referencia HORDEC ???
 ???€



MACETERO TG
 DIÁMETRO 0,58 MTS. ALTURA 0,52 MTS
 PESO APROX.: 95 KG.
 Referencia HORDEC ???
 ???€

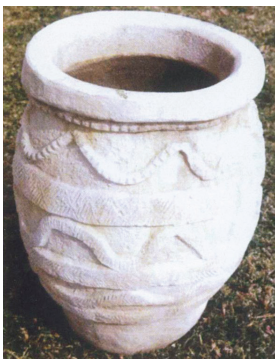

TINAJA GRANDE
 DIÁMETRO 0,46 MTS. ALTURA 0,76 MTS
 PESO APROX.: 132 KG.
 Referencia HORDEC ???
 ???€



TINAJA PEQUEÑA
 DIÁMETRO 0,40 MTS. ALTURA 0,65 MTS
 PESO APROX.: 77 KG.
 Referencia HORDEC ???
 ???€

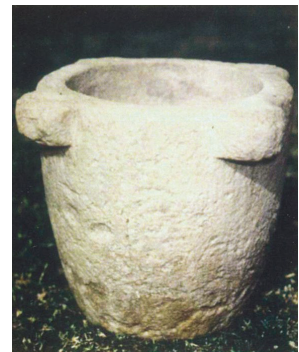

MORTERO GRANDE
 ANCHO 0,43 MTS. ALTURA 0,45 MTS
 PESO APROX.: 83 KG.
 Referencia HORDEC ???
 ???€